

PROJET NOVA TEMP™

PRODUCT DIRECTORY

HT6000+

HIGH-TEMPERATURE CHIMNEY
TESTED TO 2100°F
FOR USE WITH EFFICIENT
SOLID FUEL APPLIANCES

HT6103+

FACTORY-BUILT CHIMNEY
FOR RESIDENTIAL APPLICATIONS



**Engineered
for Efficiency**

NOVA TEMP™

ENGINEERED FOR PERFECTION

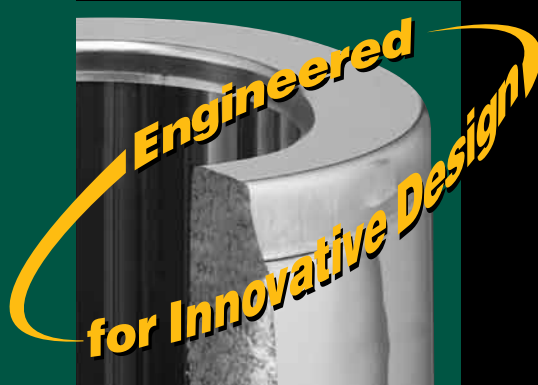

Oliver MacLeod chimneys are made of stainless steel for outstanding resistance to corrosion and feature exclusive Secura Plus-2 insulation for minimum heat loss.



Oliver MacLeod chimneys feature fast and easy Twist-Lock assembly. This system keeps installation time to a minimum. No additional part is needed!

Made of high-quality 400-series stainless steel selected for its outstanding resistance to corrosion and its astonishing looks.

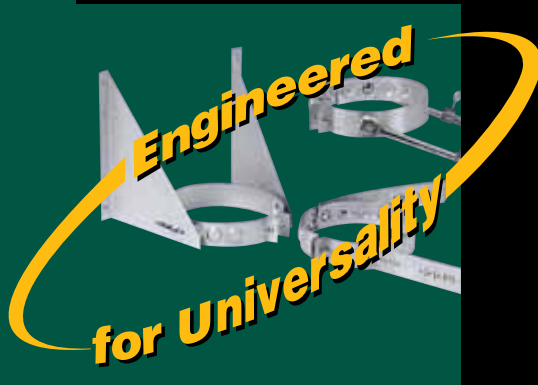

Oliver MacLeod chimneys offer a wide variety of universal accessories that add beauty and simplicity to every installation. From insulated attic and wall radiation shields to wall bands and roof supports that fit 5, 6, 7, 8 and 10" I.D. That means less SKUs!



Lifetime Limited Warranty. Security Chimneys International guarantees their stainless steel chimneys for an unlimited time from the date of purchase.

TABLE OF CONTENTS

PRODUCT DIRECTORY

Oliver MacLeod's line of venting products has benefited from continuous improvement to make it a household name for over 50 years.

Projet Nova Temp™ HT6103+

**FACTORY-BUILT
CHIMNEY**
FOR RESIDENTIAL
AND COMMERCIAL
APPLICATIONS

Subject	Page
Technical Data	4-5
Field of application	4
Design	4
Construction	4
Composition	4
Insulation	4
Installation (general info)	4
Certification	4
Warranty	4

Installation Information	8-9
Installation	8
Safety	8
Support	8
Offset	8
Connection	8
Chimney sizing	8
Assembly	8
Stability	8
Watertightness on the roof	8
Termination	8
Charts	9

Typical Installations	10-12
To a fireplace through an exterior chase	10
In condominiums with several fireplaces	10
To a furnace and water heater	11

Product Specifications	14-22
-------------------------------	--------------

Subject	Page
Technical Data	6-7
Field of application	6
Design	6
Composition	6
Insulation	6
Installation (general info)	6
Certification	6
Warranty	6
Installation Information	8-9
Installation	8
Safety	8
Support	8
Offset	8
Connection	8
Chimney sizing	8
Assembly	8
Stability	8
Watertightness on the roof	8
Termination	8
Charts	9
Typical Installations	12-13
Exterior installation to a stove	12
On a stove with finishing support	12
On a masonry fireplace	13
Product Specifications	14-22

Projet Nova Temp™ HT6000+

**HIGH-TEMPERATURE
CHIMNEY TESTED
TO 2100°F**
FOR USE WITH
EFFICIENT SOLID-FUEL
APPLIANCES

HT6103+

FACTORY-BUILT CHIMNEY FOR RESIDENTIAL AND COMMERCIAL APPLICATIONS

One of the most widely used in North America.

The Projet Nova Temp™ HT6103+ is one of the most extensively used factory-built venting systems in North America.

In Canada, the Projet Nova Temp™ HT6103+ chimney has been certified according to two standards. It has been listed to both the ULC-S629 standard for high-temperature chimneys, used with wood stoves, as well as for Type A chimneys in applications with heating units listed to ULC-S604 standards.

Continuous improvement has made Oliver MacLeod a household name for over 50 years—and one of the most popular lines of venting products in North America. Our Projet Nova Temp™ HT6103+ model is a high-quality Canadian product that ensures end-users benefit from maximum safety. Moreover, for years now, its inner lining and outer casing have provided proven corrosion protection.

Field of application

Oliver MacLeod's Projet Nova Temp™ HT6103+ chimney has been designed for residential applications and is available in diameters from 5 to 10 inches.

Developed for use with gas-fired, wood and oil-fired heating appliances, such as furnaces and hot-water heaters, it can safely withstand brief firings at 2100°F, as per ULC-S629 standards.

The Projet Nova Temp™ HT6103+ chimney is also suitable for use with closed or open factory-built wood-burning fireplaces and other products certified for use with the Projet Nova Temp™ HT6103+ chimney, per ULC-S610 standards (check manufacturer's certification). Its use is limited to diameters of 6, 7 and 8 inches.

Design

Oliver MacLeod's Projet Nova Temp™ HT6103+ model is a double-wall stainless steel chimney whose exclusive Secura Plus-2 insulation lines the cavity between the walls.

Construction

The external casing of the Projet Nova Temp™ HT6103+ carries the structural load. A free-floating inner lining is attached only to the male coupler at the top, expanding and contracting freely with temperature fluctuations.

Composition

The use of high-quality stainless steel selected for its resistance to high temperatures and corrosion lends outstanding durability to the Projet Nova Temp™ HT6103+ chimney.

Insulation

The Projet Nova Temp™ HT6103+ is lined with exclusive, superior-quality, high-density Secura Plus-2 insulation. Chimneys in diameters of 5 to 10 inches feature one inch of insulation. This exclusive insulation keeps the temperature of the outer casing relatively low, allowing all Projet Nova Temp™ HT6103+ chimneys, regardless of diameter, to be installed as close as 2 inches from combustible materials. Moreover, this insulation makes it possible to keep safety features as simple as possible.

Installation

The Projet Nova Temp™ HT6103+ (5 to 10 inch diameters) features fast and easy Twist-Lock assembly. Lengths and fittings fit together and lock into place by twisting one-eighth of a turn. No other part is needed to ensure the chimney's structural stability. This system keeps installation time to a minimum.

Certification

The Projet Nova Temp HT6103+ high-temperature chimney is certified by Intertek Testing (Warnock Hersey) to:

- ULC-S604 standards for all diameters of 5, 6, 7, 8 and 10 inches
- ULC-S610 (on wood-burning fireplaces) for all diameters of 5, 6, 7, 8 and 10 inches
- ULC-S629 for wood stove applications in diameters of 6, 7, and 8 inches
- Tested to ULC-S604

Warranty

Security Chimneys International Ltd. guarantees both its factory-built Projet Nova Temp™ HT6103+ and HT6000+ stainless steel chimneys for an unlimited time from the date of purchase. This warranty is limited to the replacement of chimney components, provided they have been properly installed and used as intended. This warranty cannot be extended by our representatives, written information or drawings.

Projet Nova Temp™ HT6103+

Ø int.	Ø ext.	Insulation thickness (in.)	Weight in lb./ft.*	Twist-Lock assembly	Clearance to combustible (in.)
5	7	1	4.1	yes	2
6	8	1	5.2	yes	2
7	9	1	6.4	yes	2
8	10	1	7.2	yes	2
10	12	1	8.9	yes	2

*Lengths produced may have a weight variance of approximately 10% compared to the above listing.

**FACTORY-BUILT
CHIMNEY**
FOR RESIDENTIAL
AND COMMERCIAL
APPLICATIONS

Particularly well suited to a range of applications, the Projet Nova Temp™ HT6103+ chimney has been specially designed in keeping with the various criteria applied to the installation and use of wood-burning fireplaces in high-temperature applications and Type A installations with gas-fired or oil-fired appliances.

The Projet Nova Temp™ HT6103+ has a number of features that account for the enviable position it has earned over the years: its easy installation and safety (both structural and thermal); its complete line of accessories; superior insulation, allowing all diameters to be installed 2 inches from combustible materials; plus proven resistance to corrosion.



Coupler system for fast assembly

The Projet Nova Temp™ HT6103+ features an easy assembly system leading to fast and easy installation requiring no screws or other attachments.

Inner wall of fast-heating stainless steel

Immediate heating of the thin inner wall. Smooth wall, little restriction of flue gases even with a 45° elbow. Outstanding corrosion resistance.

Exclusive Secura Plus-2 insulation

No shifting of the insulation. Minimal cooling of temperature, which stabilizes at high levels. Reduction of condensation and creosote buildup. Avoids corrosion caused by acid condensation.

Fast venting of combustion products

Stable and powerful draft.

Outer casing

Supports the structural load. Low surface temperature. Minimum 2-inch safety clearance from combustible materials with all diameters in the Projet Nova Temp™ HT6103+ line.

Inner liner unattached to the female coupler

Free-floating inner wall. Unhindered expansion with rising temperatures.

Lightweight

6-inch diameter – 5.2 lb. per linear foot. Installation by a single worker. For support, see "Loadbearing Capacity" chart.

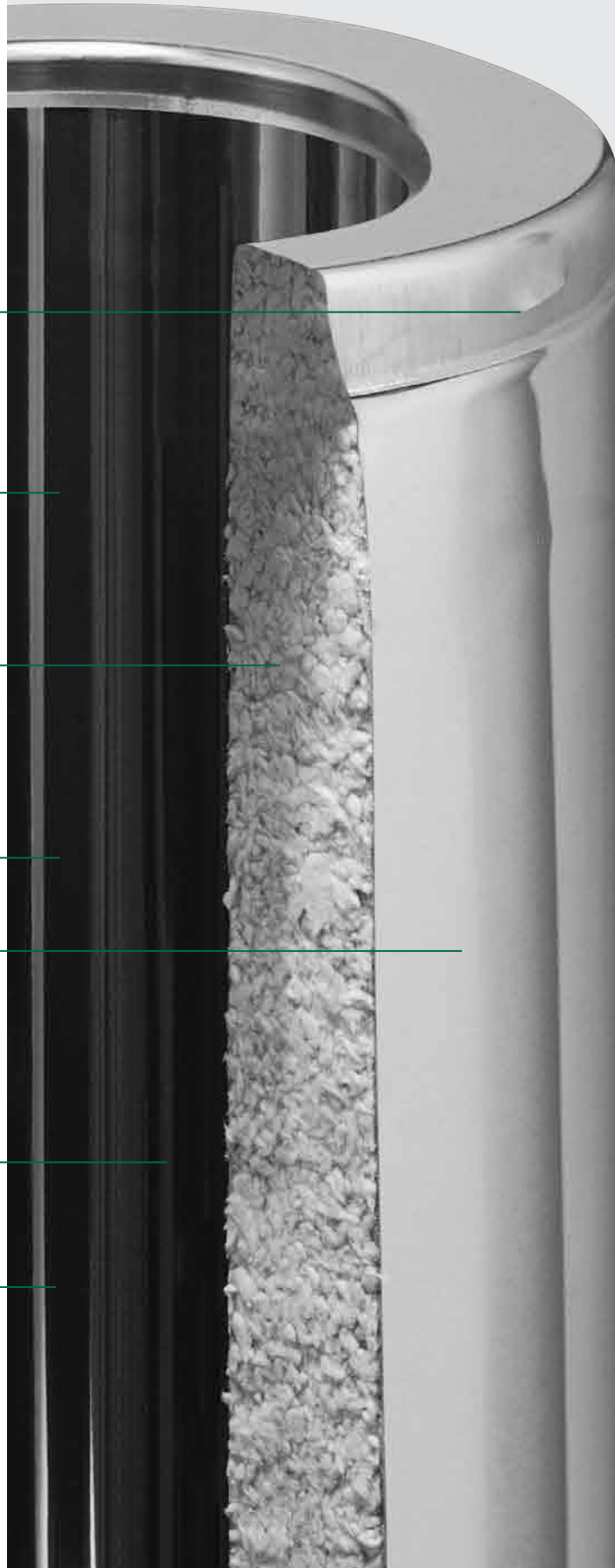

HT6000+

HIGH-TEMPERATURE CHIMNEY TESTED TO 2100°F

FOR USE WITH EFFICIENT SOLID-FUEL APPLIANCES.

Designed to widely exceed existing safety standards while offering the best available chimney system.

In fact, the Projet Nova Temp™ HT6000+ is listed to ULC-S629M standards, meeting the world’s most stringent requirements, in line with harsh Canadian weather conditions.

The Oliver MacLeod line of venting products has benefited from continuous improvement to make it a household brand for over 50 years.

The Projet Nova Temp™ HT6000+ is a high-quality product offering maximum protection from chimney fires capable of reaching temperatures of 2100°F. Moreover, its inner lining and outer casing have provided proven corrosion protection.

Field of application

Oliver MacLeod’s Projet Nova Temp™ HT6000+ high-temperature chimney has been designed for use with wood, gas, oil and coal in mainly residential, but also commercial and industrial, applications.

Specially developed for use with controlled-combustion stoves and wood-burning fireplaces, the Projet Nova Temp™ HT6000+ high-temperature chimney has been listed to ULC-S629M.

Recommended whenever an exterior installation is unavoidable, its superior insulation improves the performance of the chimney and appliance, especially in cold climates.

Design

The external casing of the Projet Nova Temp™ HT6000+ high-temperature chimney carries the structural load. A free-floating inner lining is attached only to the male coupler at the top, expanding and contracting freely with temperature fluctuations.

Composition

The use of various gauges of stainless steel specially selected for their compatibility with high temperatures and corrosion resistance lends outstanding durability to the Projet Nova Temp™ HT6000+ high-temperature chimney.

Insulation

The Oliver MacLeod Projet Nova Temp™ HT6000+ is a double-wall, all-stainless steel chimney, with a 2-inch thickness of exclusive high-density Secura Plus-2 insulation. This exclusive insulation minimizes heat loss through the chimney walls and keeps the temperature of the outer casing relatively low, allowing the Projet Nova Temp™ HT6000+ high-temperature chimney to be installed 2 inches from combustible materials, regardless

of the diameter. Moreover, this insulation makes it possible to keep safety features as simple as possible.

Installation

The Projet Nova Temp™ HT6000+ high-temperature chimney features fast and easy Twist-Lock assembly. Lengths and universal fittings fit together and lock into place by twisting one-eighth of a turn. No other part is needed to ensure the chimney’s structural stability. This system keeps installation time to a minimum.

Certification

The Projet Nova Temp™ HT6000+ high-temperature chimney was the first factory-built chimney to be tested and certified by Intertek Testing (Warnock Hersey) to ULC-S629 at the following temperatures:

Allowable flue gas temperature:

Maximum continuous
1200°F (650°C)

Brief forced firing
1400°F (760°C)

Tested to
2100°F (1150°C)
3 x 30 minutes

Warranty

Security Chimneys International Ltd. guarantees both its factory-built Projet Nova Temp™ HT6103+ and HT6000+ stainless steel chimneys for an unlimited time from the date of purchase. This warranty is limited to the replacement of chimney components, provided they have been properly installed and used as intended. This warranty cannot be extended by our representatives, written information or drawings.

Projet Nova Temp™ HT6000+

Ø int.	Ø ext.	Insulation thickness (in.)	Weight in lb./ft.*	Twist-Lock assembly	Clearance to combustible (in.)
6	10	2	8.9	yes	2
7	11	2	9.9	yes	2
8	12	2	10.9	yes	2

*Lengths produced may have a weight variance of approximately 10% compared to the above listing.

HIGH-TEMPERATURE CHIMNEY TESTED TO 2100°F

FOR USE WITH
EFFICIENT SOLID-FUEL
APPLIANCES.

The Projet Nova Temp™ HT6000+ high-temperature chimney is one of the safest chimneys in North America.

Controlled-combustion units produce creosote buildup in the chimney when operating in a low regime. The creosote buildup can cause chimney fires capable of reaching temperatures of up to 2100°F.

Over the years, the HT6000+ has become the chimney system most widely recommended by municipal fire departments. Its design and insulation have made it one of the safest chimney systems on the market.



Coupler system for fast assembly

The Projet Nova Temp™ HT6000+ features a fast and easy Twist-Lock assembly system. No screws or other parts are needed to secure the chimney installation.

Twist-Lock system: 1/8 turn assembly.

Overlap: 1 inch.

Stainless steel inner lining with low reaction to heat

Thin inner lining for immediate heating.

Smoother surface; little restriction of flue gases even with a 45° elbow.

Outstanding corrosion resistance.

Two inches of exclusive Secura Plus-2 insulation

No settling of the insulation.

Minimal cooling of gas temperature, which stabilizes at high levels.

Reduction of condensation and creosote buildup.

Avoids corrosion caused by acid condensation.

Increases appliance performance especially in cold climate.

Fast venting of combustion products

Stable and powerful draft.

Outer casing

Supports the structural load.

Low surface temperature.

Minimum 2-inch safety clearance to combustible materials in all diameters of 6, 7 and 8 inches.

Inner liner unattached to the female coupler

Free-floating inner wall – no need for expansion joints.

Unhindered expansion with rising temperatures.

Lightweight

6-inch diameter – 8.9 lb. per linear foot.

User friendly.

For support, see "Loadbearing Capacity" chart.

Numbered reference on illustration, cross-sectional view.

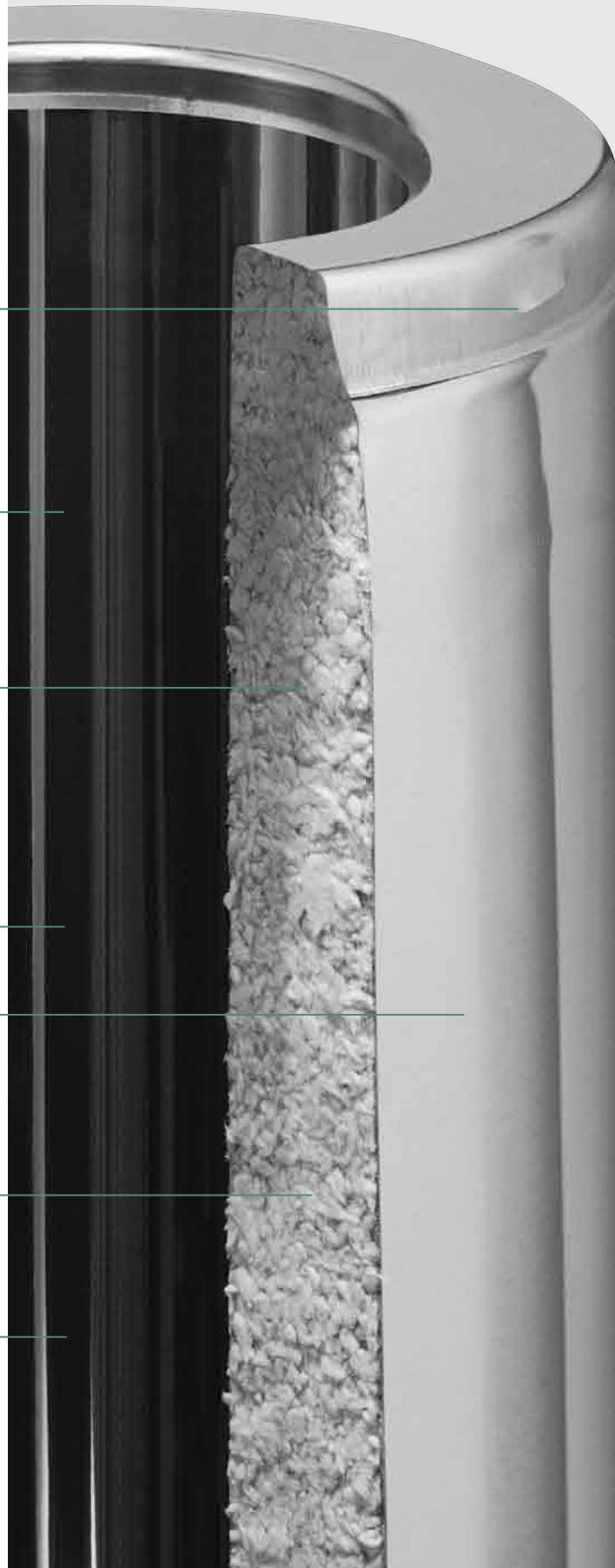

HT6103+ HT6000+

THE CHOICE FOR WOOD STOVE APPLICATIONS

With the Projet Nova Temp™ HT6000+ and HT6103+ chimneys certified for wood stove applications, Oliver MacLeod now offers two options for wood smoke evacuation:

- The HT6000+, with 2 inches of insulation, is well-suited for outside installations in areas where very cold temperatures occur.
- The HT6103+, with its smaller diameter, is the perfect choice for inside and outside installations with limited space for maneuvers.

Installation

Assembly always requires the male coupler to be positioned upwards. Size the chimney in accordance with the appliance instruction manual. Map out the chimney path closest to the heating unit.

For wood stove applications, a third pipe (premium shield) is required for inside installation where the chimney is enclosed between two floors (see premium shield accessories section). Prior to installation, consult the detailed installation manual included with the support components.

Safety

Oliver MacLeod's Projet Nova Temp™ HT6103+ and HT6000+ chimneys can be installed as close as 2 inches to combustible materials, regardless of the diameter to be used. Radiation shields and appropriate supports must be used to maintain a safe clearance as the chimney passes through floors and combustible partitions.

Some radiation shields in the Projet Nova Temp™ HT6103+ line have been designed specifically for use with wood applications. Please refer to the installation instructions for more details. For the use of Projet Nova Temp™ HT6103+ with other manufactured fireplaces, refer to the certification of these products. Available in diameters of 6, 7, 8 and 10 inches only.

As several radiation shields are available, consult the section on Firestops for specific uses.

Support

Different types of supports are available to meet the requirements of various types of installation. When the height of the installation exceeds the loadbearing capacity, use an additional support, such as:

- base support
- anchor plate
- adjustable wall support
- roof support
- offset support/or wall support
- wall support*
- cathedral support*
- square cathedral support*
- finishing support*

* HT6000+ only

Offset

Elbows angled at 15°, 30° or 45° are available to offset the Projet Nova Temp™ HT6103+ chimney, by-passing joists and other obstacles (15° and 30° for the Projet Nova

Temp™ HT6000+). A maximum offset of 45° is allowed for the Projet Nova Temp™ HT6103+ and Projet Nova Temp™ HT6000+. Two offsets (total of 4 elbows) per installation are permitted.

Connection

The use of a 90° insulated tee allows the lateral connection of the chimney or heating appliance. Thanks to its insulation, it can be safely installed close to combustible materials. It can be used to pass through a wall or at the base of an interior installation. It also provides easy access for inspection or cleaning purposes, and is often used when passing through an exterior wall.

For indoor use with Projet Nova Temp™ HT6103+ product, a base tee facilitates chimney inspection and cleaning. Available in galvanized steel, it provides the necessary clearance for the connection of a simple black pipe length. A base tee with two openings is also available for connecting two appliances (Type A, ULC-S604 application only). Tees come with a tee cap.

Chimney sizing

A chimney's diameter must be well suited to the appliance's specifications and combustion parameters. It is advisable to consult the Oliver MacLeod chart established for this purpose. In the case of a fireplace, check its certification with regard to the chimney.

All fireplaces and controlled-combustion units can be connected to the Projet Nova Temp™ HT6000+ since it has been certified, independently, to ULC-S629M standards.

Assembly

All fireplace products from Security Chimneys International are connected directly to the chimney using the Twist-Lock system. Most other fireplaces certified for use with the Projet Nova Temp™ HT6103+ high-temperature chimney can also be installed directly or with an anchor plate. All other connections to appliances, such as furnaces, boilers and water heaters, can be made using a flue extension that attaches to the female connector of the last section. Fireplaces can be connected directly to the Projet Nova Temp™ HT6000+ chimney using an adaptor.

A flue extension is available for connections to single or double-wall black pipes. An anchor plate is also available for connecting other types of places, including masonry units.

Stability

a) Vertical installation

Universal wall bands ensure the stability of the chimney. While these bands are not loadbearing components, they are necessary to ensure the chimney's lateral stability and should be used every 8 feet. A reinforced wall band should be used every 10 feet from a support.

Also available is a wall band extension, which is used in combination with a reinforced wall band to extend the clearance between the chimney and wall surface by 2 to 5 inches.

b) Chimney through the roof

No support is required for free-standing chimneys extending up to 5 feet beyond the roof line in areas subject to normal weather conditions.

* Roof brace (0 to 9 feet)

Used in areas subject to high winds, to stabilize the chimney, or on sloped roofs, to stabilize chimneys between 5 and 9 feet beyond the roof. Adjustable braces adapt to the slope of the roof (from 60 to 115 inches for the Projet Nova Temp™ HT6103+ and HT6000+).

* Guy wire band (5 to 13 feet)

Beyond 5 feet, to a maximum height of 13 feet, Projet Nova Temp™ HT6103+ and HT6000+ chimneys can be stabilized using guy wire bands.

Watertightness on the roof

A roof flashing is required when the chimney passes through the roof. Several types are available to adapt to the full range of roof pitches.

Six types of flashing are offered:

- flat roof flashing
- flashing for sloped roof 1/12 to 7/12*
- flashing for sloped roof 8/12 to 12/12*
- flashing for sloped roof 12/12 to 21/12*
- flashing for peak roof 1/12 to 7/12 (6" to 10" only)*
- flashing for peak roof 7/12 to 12/12 (6" to 10" only)

*Adjustable flashings

Termination

A chimney must have a termination cap. A universal rain cap is available for the Projet Nova Temp™ HT6103+ and HT6000+.

Installation Calculations.

The following steps will help determine the lengths required for an installation:

1. Determine the offset required in view of the obstacles that must be avoided. Refer to the chart to determine the elbows required as well as the insulated lengths needed.

2. Check the corresponding offset height dimensions.

Note:

The dimensions given for the height of the offset listed in the following charts refer to effective lengths after assembly.

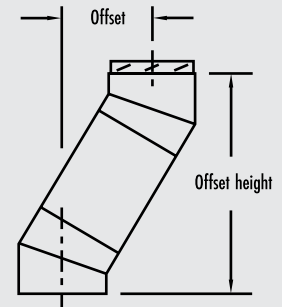

Note: Shift or offset is centerline to centerline

Loadbearing Capacity

Ø int.	Maximum height in feet							
	5	6	7	8	10	6	7	8
Supports	Projet Nova Temp™ HT6103+				Projet Nova Temp™ HT6000+			
Base support	32	32	32	32	32			
Anchor plate	50	50	42	37	31			
Wall support	63	63	55	48	39	30	28	26
Adjust. wall support	63	63	55	48	39	30	28	26
Roof support	42	34	27	24	20	20	18	16
Offset support		28	24	20	14	18	16	14
Cathedral support						30	28	26
Sq. Cathedral support						30	28	26
Finish support						30	28	26

Size of Openings*

Ø int.	Hole (framing) size							
	5	6	7	8	10	6	7	8
Supports	Projet Nova Temp™ HT6103+				Projet Nova Temp™ HT6000+			
Base support	14 3/8	14 3/8	14 3/8	14 3/8	14 3/8			
Roof support	11 3/8	12 3/8	13 3/8	14 3/8	16 3/8	14	15	16
Radiation shield	11 3/8	12 3/8	13 3/8	14 3/8	16 3/8	14	15	16
Cathedral support						14 3/8	14 3/8	14 3/8
Sq. Cathedral support						14 3/8	14 3/8	14 3/8
Finish support						14 3/8	14 3/8	14 3/8

*The size of the opening may vary depending on the pitch of the roof. Maintain a 2-inch clearance from the chimney.

Chart for the selection of lengths

This chart will make it easier for you to calculate the exact height of the chimney installation. It will enable you to deduct the value of the overlaps. Follow the steps below:

1. Determine the height of the installation.
E.g., 32 feet.
2. Determine the combination of lengths required to reach this height.
E.g., 10 X 61--SL36 = 30 feet + 61--SL24 = 32 feet.
3. Calculate the number of sections used and deduct ONE value to obtain the number of overlaps involved.
E.g., 11 sections - 1 = 10 overlaps.
4. Consult the charts to obtain the height to be deducted due to the overlaps.
E.g., 32 feet - 11-7/8 in. = 31 ft. 1/8 in.

If necessary, complete your estimation of the number of lengths by adding one of the following sections: SL8, SL12, SL18, SL24, SL36 or SL48

Twist-Lock System (Ø int. 5 to 10 inches) Projet Nova Temp™ HT6103+

Number of overlaps								
1	2	3	4	5	6	7	8	
1 3/16	2 3/8	3 9/16	4 3/4	5 15/16	7 1/8	8 5/16	9 1/2	
9	10	11	12	13	14	15		
10 11/16	11 7/8	13 1/8	14 1/4	15 7/16	16 5/8	17 13/16		

For HT6000+, use 1 in/overlap.

		Projet Nova Temp™ HT6103+								
		One length between elbows (in.)								
Angle	Size	8	12	18	24	36	48			
15	5 @ 10 in.	Offset (in.)	3 5/16	4 5/16	5 7/8	7 7/16	10 1/2	13 5/8		
		Rise (in.)	15 11/16	19 9/16	25 3/8	31 3/16	42 3/4	54 3/8		
		Two lengths between elbows (in.)								
		8 & 48	12 & 48	18 & 48	24 & 48	36 & 48	48 & 48			
		Offset (in.)	15 3/8	16 7/16	18	19 1/2	22 5/8	25 3/4		
		Rise (in.)	60 15/16	64 13/16	70 9/16	76 3/8	87	99 9/16		

		Projet Nova Temp™ HT6103+								
		One length between elbows (in.)								
Angle	Size	8	12	18	24	36	48			
30	5 @ 10 in.	Offset (in.)	7 7/16	9 7/16	12 7/16	15 7/16	21 7/16	27 7/16		
		Rise (in.)	20	23 1/2	28 11/16	33 7/8	44 1/4	54 11/16		
		Two lengths between elbows (in.)								
		8 & 48	12 & 48	18 & 48	24 & 48	36 & 48	48 & 48			
		Offset (in.)	30 13/16	32 13/16	35 13/16	38 13/16	44 13/16	50 13/16		
		Rise (in.)	60 9/16	64	69 1/4	74 7/16	84 13/16	95 1/4		

		Projet Nova Temp™ HT6103+								
		One length between elbows (in.)								
Angle	Size	8	12	18	24	36	48			
45	5 @ 10 in.	Offset (in.)	10 5/16	13 3/16	17 3/8	21 5/8	30 1/8	38 5/8		
		Rise (in.)	17 13/16	20 5/8	24 7/8	29 1/8	37 5/8	46 1/8		
		Two lengths between elbows (in.)								
		8 & 48	12 & 48	18 & 48	24 & 48	36 & 48	48 & 48			
		Offset (in.)	43 7/16	46 1/4	50 1/2	54 3/4	63 1/4	71 11/16		
		Rise (in.)	50 15/16	53 3/4	58	62 1/4	70 3/4	79 3/16		

		Projet Nova Temp™ HT6000+								
		One length between elbows (in.)								
Angle	Size	8	12	18	24	36	48			
15	6 @ 8 in.	Offset (in.)	3 5/16	4 5/16	5 7/8	7 7/16	10 1/2	13 5/8		
		Rise (in.)	16	19 7/8	25 11/16	31 1/2	43 1/16	54 5/8		
		Two lengths between elbows (in.)								
		8 & 48	12 & 48	18 & 48	24 & 48	36 & 48	48 & 48			
		Offset (in.)	15 1/2	16 1/2	18 1/16	19 5/8	22 3/4	25 13/16		
		Rise (in.)	61 7/16	65 1/4	71 1/16	76 7/8	88 1/2	100 1/16		

		Projet Nova Temp™ HT6000+								
		One length between elbows (in.)								
Angle	Size	8	12	18	24	36	48			
30	6 @ 8 in.	Offset (in.)	7 3/8	9 3/8	12 3/8	15 3/8	21 3/8	27 3/8		
		Rise (in.)	20 11/16	24 3/16	29 3/8	34 9/16	44 15/16	55 5/16		
		Two lengths between elbows (in.)								
		8 & 48	12 & 48	18 & 48	24 & 48	36 & 48	48 & 48			
		Offset (in.)	30 7/8	32 7/8	35 7/8	38 7/8	44 7/8	50 7/8		
		Rise (in.)	61 3/8	64 7/8	70 1/16	75 1/4	85 5/8	96		

		Projet Nova Temp™ HT6000+								
		One length between elbows (in.)								
Angle	Size	8	12	18	24	36	48			
45	5 @ 10 in.	Offset (in.)	10 5/16	13 3/16	17 3/8	21 5/8	30 1/8	38 5/8		
		Rise (in.)	17 13/16	20 5/8	24 7/8	29 1/8	37 5/8	46 1/8		
		Two lengths between elbows (in.)								
		8 & 48	12 & 48	18 & 48	24 & 48	36 & 48	48 & 48			
		Offset (in.)	43 7/16	46 1/4	50 1/2	54 3/4	63 1/4	71 11/16		
		Rise (in.)	50 15/16	53 3/4	58	62 1/4	70 3/4	79 3/16		

PROJET Nova Temp™ TYPICAL INSTALLATIONS

HT6103+

Oliver MacLeod's Projet Nova Temp™ HT6103+ factory-built, high-quality chimneys have been designed for ease of installation and maximum safety in many applications, featuring our fast and easy Twist-Lock assembly system. No other part is required to ensure the stability of the installation. See how simple typical installations are in the following diagrams.

Installation of a Projet NovaTemp™ HT6103+ high-temperature chimney to a fireplace with an offset and through an exterior insulated chase.

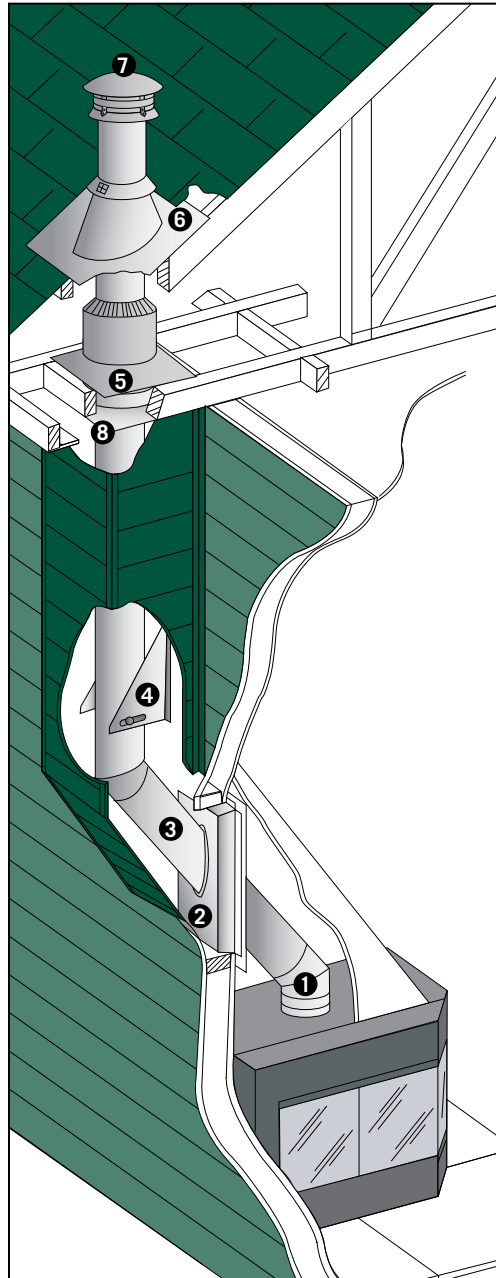

1. Insulated elbow
2. Insulated wall radiation shield
3. Insulated length
4. Universal offset support
5. Insulated attic radiation shield
6. Adjustable roof flashing with storm collar
7. Rain cap
8. Firestop

Interior installation of a Projet NovaTemp™ HT6103+ high-temperature chimney in condominiums with several fireplaces.

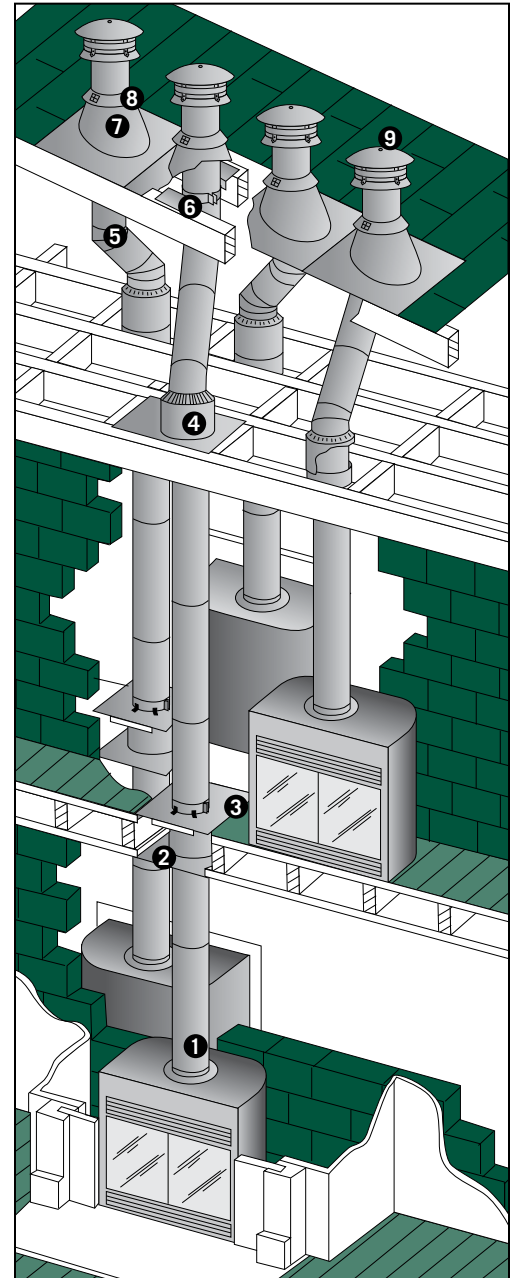

1. Insulated length
2. Firestop
3. Floor support
4. Insulated attic radiation shield
5. Insulated elbow
6. Universal roof support
7. Adjustable roof flashing
8. Storm collar
9. Rain cap

Interior installation of a Projet Nova Temp™ HT6103+ chimney to a residential furnace and water heater.

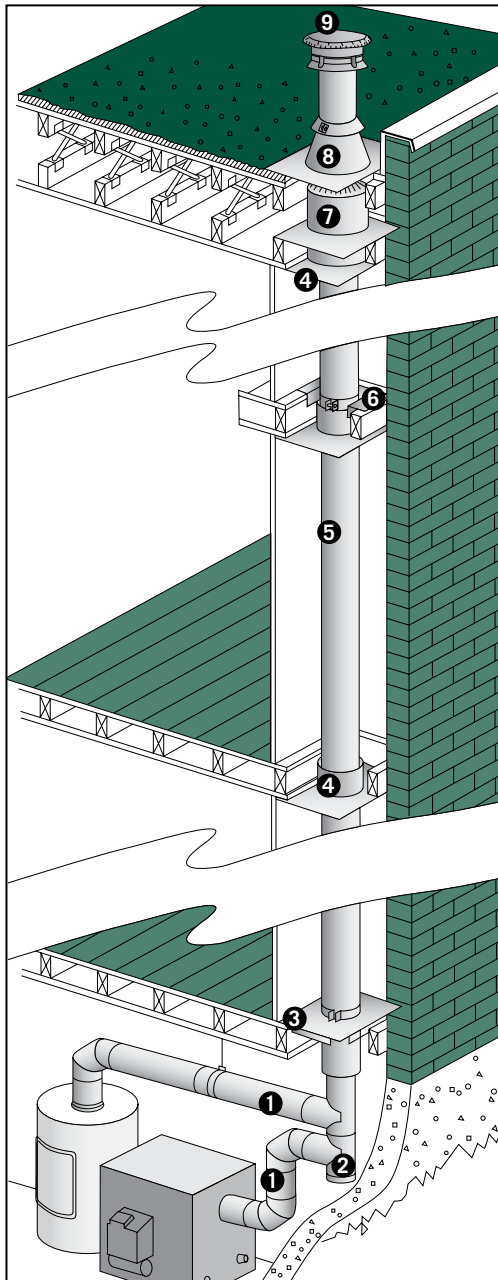

1. Connector
2. Base tee for twin connections
3. Floor support (or base support)
4. Firestop
5. Insulated length
6. Universal roof support
7. Insulated attic radiation shield
8. Flat roof flashing and storm collar
9. Rain cap

Interior enclosed installation of a Projet NovaTemp™ HT6103+ chimney on a wood stove using a finishing support.

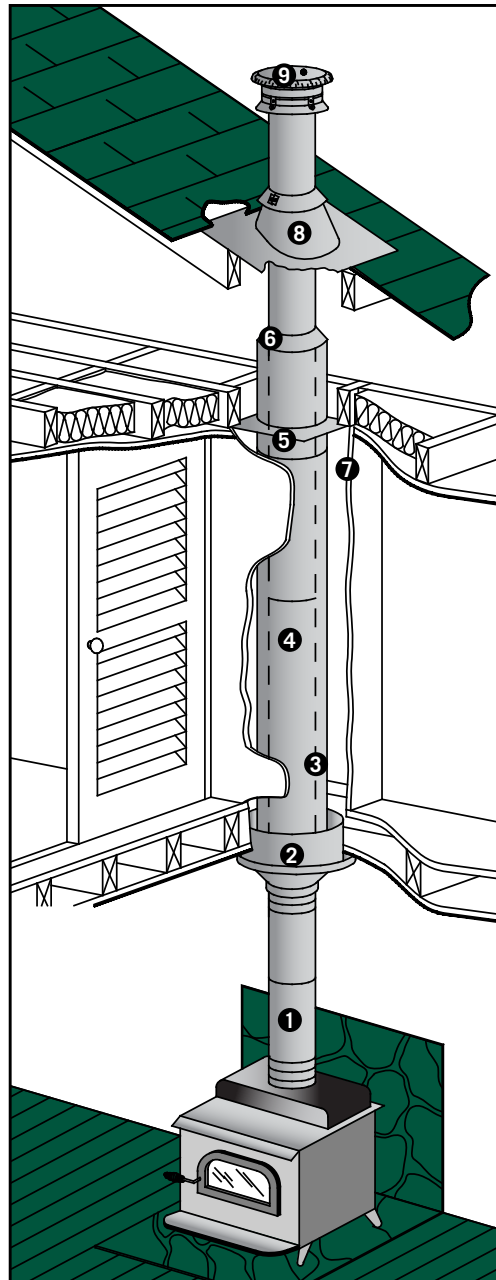

1. Black stove pipe
2. Finishing support
3. Telescopic rigid shield
4. Insulated length
5. Radiation shield connector
6. Storm collar
7. Radiation shield connector firestop
8. Flashing
9. Rain cap

PROJET Nova Temp™ TYPICAL INSTALLATIONS

HT6000+

Over the years, the Projet Nova Temp™ HT6000+ high-temperature chimney has become the chimney system most widely recommended by municipal fire departments. Its design and insulation have made it one of the safest chimney systems on the market today.

Exterior installation of a Projet NovaTemp™ HT6000+ high-temperature chimney to a wood stove.

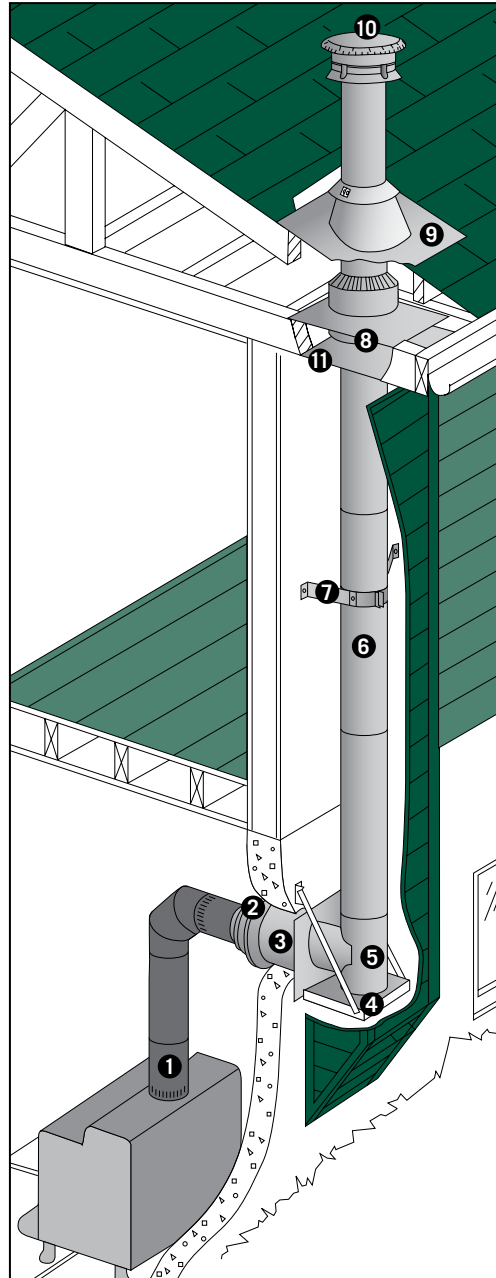

1. Black stovepipe
2. Finishing cone
3. Insulated wall radiation shield
4. Wall support
5. Insulated tee
6. Insulated length
7. Universal wall band
8. Insulated attic radiation shield
9. Adjustable roof flashing with storm collar
10. Rain cap
11. Firestop

Interior installation of a Projet NovaTemp™ HT6000+ high-temperature chimney on a wood stove using a finishing support.

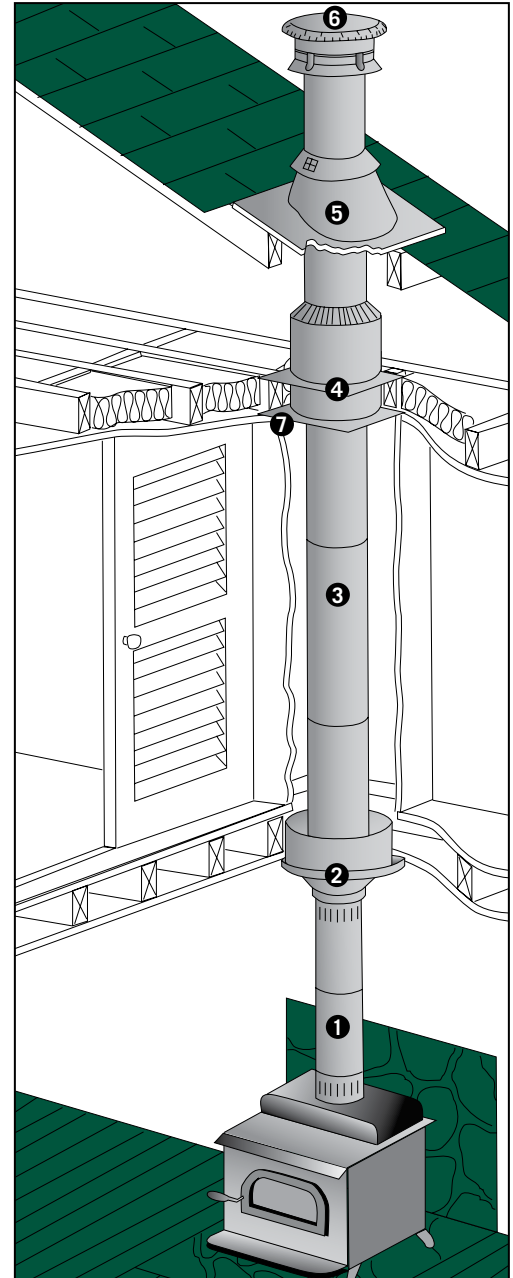

1. Black stovepipe
2. Finishing support
3. Insulated length
4. Insulated attic radiation shield
5. Adjustable roof flashing with storm collar
6. Rain cap
7. Firestop

Projet NovaTemp™ HT6000+ chimney installed on a masonry fireplace.

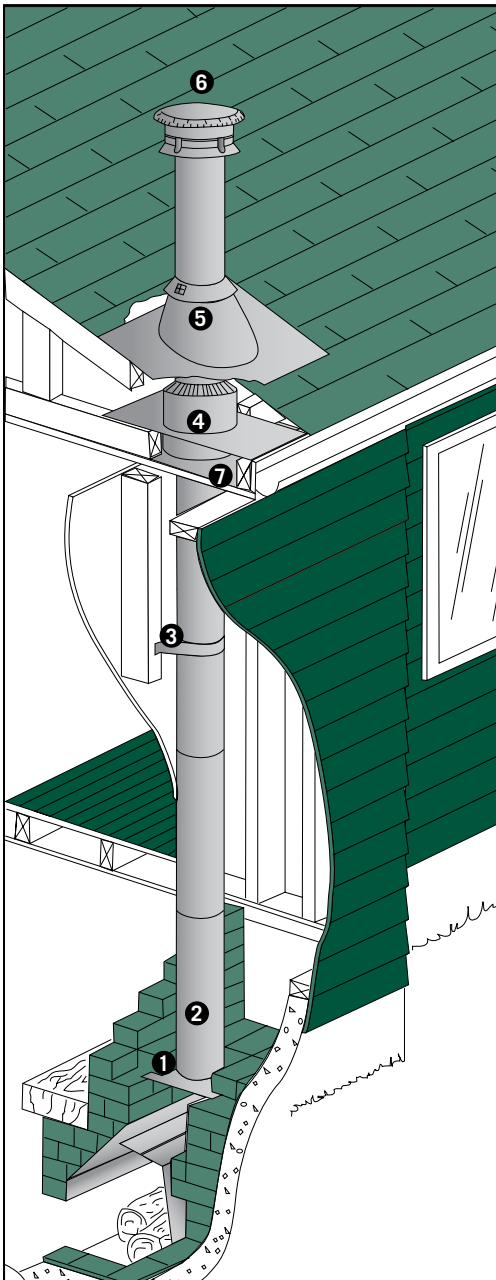

1. Anchor plate
2. Insulated length
3. Universal wall band
4. Insulated attic radiation shield
5. Adjustable roof flashing with storm collar
6. Rain cap
7. Firestop

PROJET Nova Temp™ PRODUCT SPECIFICATIONS

HT6103+ HT6000+

Coding logic This document contains a description of each of the parts for the **Projet Nova Temp™ HT6103+** and **HT6000+** systems, as well as their respective application. Each part has a reference letter that identifies the product. The following examples of our coding system should make it easier for you to identify or order them.

Insulated Lengths

HT6103+:
5 diameters and 6 standard effective lengths featuring a 1/8-turn Twist-Lock assembly.

HT6000+:
3 diameters and 6 standard effective lengths featuring a 1/8-turn Twist-Lock assembly.

Various lengths may be combined to obtain the required installation height.

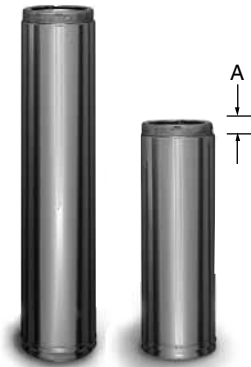

6106SL36		6106RF17	
Size	6 Interior diameter	6 Interior diameter	
Reference	SL Insulated length	RF Roof flashing	
Specificity	36 Insulated 36" length	17 Adjustable	

Ref. 61--SL					
Ø int.	5	6	7	8	10
Ø ext.	7	8	9	10	12
8		•	•	•	•
12	•	•	•	•	•
18		•	•	•	•
24	•	•	•	•	•
36	•	•	•	•	•
48	•	•	•	•	•
Lb./ft.	4.1	5.2	6.4	7.2	8.9
A	1 3/16	1 3/16	1 3/16	1 3/16	1 3/16

Ref. 61--SLA					
Ø ext.	5	6	7	8	10
A	11 1/4	11 1/4	11 1/4	11 1/4	11 1/4

6006SL36		6006IWR530	
Size	6 Interior diameter	6 Interior diameter	
Reference	SL Insulated length	IW Insulated wall	
Specificity	36 36" length	RS Radiation shield	
		30	30° angle

Ref. 60--SL			
Ø int.	6	7	8
Ø ext.	10	11	12
8	•	•	•
12	•	•	•
18	•	•	•
24	•	•	•
36	•	•	•
48	•	•	•
Lb./ft.	8.9	9.9	10.9
A	1"	1"	1"

Ref. 60--SLA			
Ø int.	6	7	8
Ø ext.	11 1/4	11 1/4	11 1/4
A	11 1/4	11 1/4	11 1/4

Adjustable Length 12"

Used in combination with a straight insulated length, the adjustable length makes it possible to precisely match the height of a chimney.

IMPORTANT: The adjustable length is not designed as a loadbearing component. Its vertical installation requires an appropriate support.

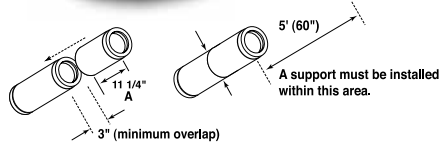

Insulated Tee

Located at the base of the chimney, it allows the horizontal connection of the chimney to the appliance and provides access for inspection and cleaning. An insulated tee cap (PTCS), included, must be used with wall support.

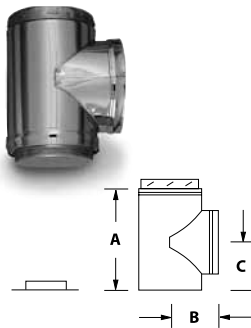

Ref. 61--ITS					
Ø int.	5	6	7	8	10
Ø ext.	7	8	9	10	12
A	9 1/2	10 3/4	11 3/4	13	15
B	4 3/4	5 1/4	5 3/4	6 1/4	7 1/4
C	5 1/2	6	6 1/2	7 1/4	8 1/4

Ref. 60--ITS			
Ø int.	6	7	8
Ø ext.	10	11	12
A	13 1/4	13 3/4	14 13/16
B	7	7 1/2	8
C	7	7 1/4	8

Insulated Tee Cap

Equipped with a Twist-Lock system, it makes it possible to seal the base of an insulated tee. Its insulation also prevents the cooling of chimney gases, especially in exterior installations. Must be combined with an adjustable wall or offset support. Removable, it provides easy access for chimney maintenance or inspection.



Ref. 61--IC					
Ø int.	5	6	7	8	10

Ref. 60--IC			
Ø int.	6	7	8

Projet Nova Temp™ HT6103+

Ref. IF--BT/BT2

Ø int.	6	7	8	10
A (BT)	23	24	25	27
A (BT2)	31	33	35	39
B	18	18½	19	20
C	5	5½	6	7
D	5½	6	6½	7½
E	8	9	10	12

Projet Nova Temp™ HT6000+

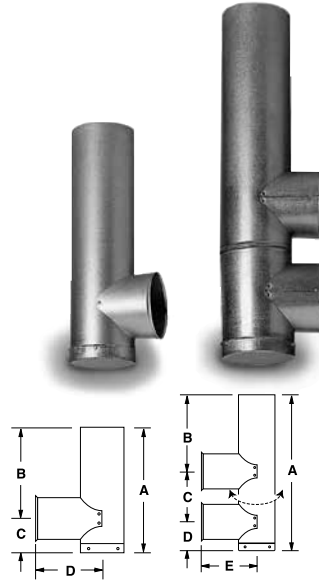

Base Tee

Located at the base of the chimney, it makes it possible to connect the chimney to the appliance (Type A application, ULC-S604 only). It is recommended for interior installation only and must be attached to a flue extension. The base tee comes with a tee cap, providing access for inspection and cleaning. Available in galvanized steel.

Base Tee for Twin Connections (BT2)

This component makes it possible to connect two appliances, such as a furnace and a water heater, to the **Projet Nova Temp™ HT6103+** chimney (Type A application, ULC-S604 only). The galvanized steel base tee for twin connections comes with a tee cap, providing access for inspection and cleaning.

Ref. 61--IES15

Ø int.	5	6	7	8	10
Ø ext.	7	8	9	10	12
A	½	½	½	½	½
B	4½	4½	4½	4½	4½

Ref. 60--IES15

Ø int.	6	7	8
Ø ext.	10	11	12
A	5/8	5/8	5/8
B	4¾	4¾	4¾

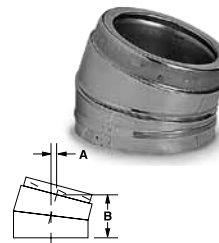

15° Insulated Elbow

Allows the 15° offset of a chimney. Designed to bypass an obstacle, such as a joist. A maximum of two offsets (4 elbows) is allowed. The minimum recommended height for an installation with a 15° offset is 10 feet.

Ref. 61--IES30

Ø int.	5	6	7	8	10
Ø ext.	7	8	9	10	12
A	2	2	2	2	2
B	7½	7½	7½	7½	7½

Ref. 60--IES30

Ø int.	6	7	8
Ø ext.	10	11	12
A	1 15/16	1 15/16	1 15/16
B	7 5/16	7 5/16	7 5/16

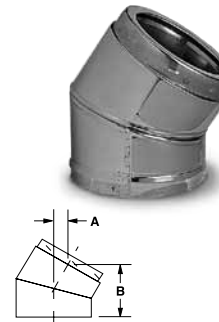

30° Insulated Elbow

Allows the 30° offset of a chimney. Designed to bypass an obstacle, such as a joist. A maximum of two offsets (4 elbows) is allowed. The chimney's angle of inclination must not deviate more than 30° from the vertical position. The minimum recommended height for an installation with a 30° offset is 15 feet.

Ref. 61--IES45

Ø int.	5	6	7	8	10
Ø ext.	7	8	9	10	12
A	3	3	3	3	3
B	6 7/8	6 7/8	6 7/8	6 7/8	6 7/8

Ref. 60--IES45

Ø int.	6	7	8
Ø ext.	10	11	12
A	3	3	3
B	6 7/8	6 7/8	6 7/8

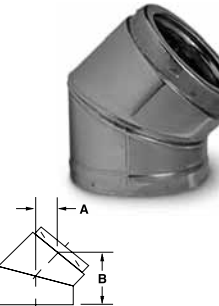

45° Insulated Elbow

Allows the 45° offset of a chimney. Designed to bypass an obstacle, such as a joist. A maximum of two offsets (4 elbows) is allowed. The chimney's angle of inclination must not deviate more than 45° from the vertical position. The minimum recommended height for an installation with a 45° offset is 20 feet.

Ref. 61--BS2

Ø int.	5	6	7	8
A	12	12	14 3/8	14 3/8
B	5	6 ¼	7 ½	8 ¼
C	17	17	20	20
D	5 ½	5 ½	5 ½	5 ½
E	3	3	3	3



Base Support

This part supports the chimney from a floor or ceiling joist. It includes a radiation shield that makes it possible to maintain a 2-inch clearance between the chimney's outer casing and combustible materials in its path. The base support is attached to a frame from the joists. (Refer to charts for loadbearing capacity and frame sizes.)

HT6103+ HT6000+

Floor Support

This part supports the chimney on a slab, floor or joist. It makes it possible to maintain a minimum 2-inch clearance between the chimney's outer casing and combustible materials in its path. A tightening collar locked around the chimney and secured by self-taping screws (supplied) rests on a horizontal plate screwed or nailed to the floor or slab, which can serve as an intermediate support. (Refer to the chart for loadbearing capacity.)

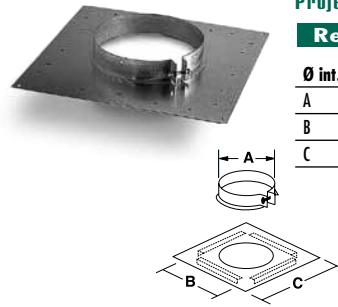

Projet Nova Temp™ HT6103+

Ref. 61--ISP					
Ø int.	5	6	7	8	10
A	7	8	9	10	12
B	11	12	13	14	16
C	16	16	16	18	18

Universal Roof Support

This complementary support is usually attached to a roof structure. It is designed to support the chimney:

- from the roof, adjusting to any roof pitch
- above an offset
- when the chimney height exceeds the load-bearing capacity of the primary support

Two adjustable plates screwed to the structure adapt to the pitch of the roof. A tightening collar attached around the chimney is supplied. (Refer to the chart for loadbearing capacity.)

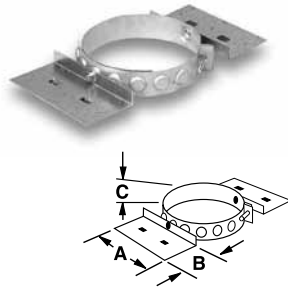

Ref. PST					
Fits 5, 6, 7 and 8" HT6103+					
Ø int.	5	6	7	8	
A	8	8	8	8	
B	4	4	4	4	
C	2	2	2	2	

Projet Nova Temp™ HT6000+

Ref. PXST				
Fits 6, 7 and 8" HT6000+ and 10" HT6103+				
Ø int.	6	7	8	
A	8	8	8	
B	4	4	4	
C	2	2	2	

Wall Support/ Adjustable Wall Support

This part supports the chimney at the base of the installation. It is designed with a male coupler to accommodate the first section of the chimney. This base support is made of galvanized steel and must be installed with the insulated tee cap included with the tee. The adjustable wall support (60--WSA) allows a 2- to 7-inch lateral adjustment to the vertical surface. (Refer to the chart for loadbearing capacity.)

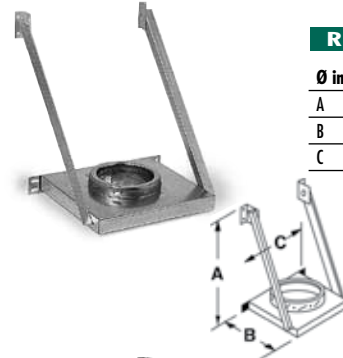

Ref. 61--WS					
Ø int.	6	7	8	10	
A	19	19	19	16	
B	13	13	13	16	
C	16	16	16	16	

Ref. 60--WS/60--WSA				
Ø int.	6	7	8	
A	18	18	18	
B	14 1/2	16	16	
C	16	16	16	

Adjustable Wall Support

This part supports the chimney at the base of the installation, or along a wall or other vertical surface serving as an intermediate support. It comes with a tightening collar locked around the chimney and secured by two self-taping screws (supplied). The collar rests on a horizontal plate. The support allows a 2- to 6-inch lateral adjustment to the vertical surface. When used as a base support, it lends itself to the addition of an insulated tee cap or drain tee cap. Available in galvanized steel. (Refer to the chart for loadbearing capacity.)

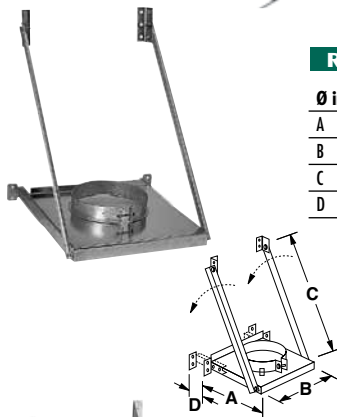

Ref. 61--AWS					
Ø int.	5	6	7	8	10
A	13	13	13	13	16
B	16	16	16	16	16
C	26 3/4	26 3/4	26 3/4	26 3/4	26 3/4
D	0 to 5	0 to 5	0 to 5	0 to 5	0 to 5

Ref. 60--AWS				
Ø int.	6	7	8	
A	15 1/2	15 1/2	15 1/2	
B	15	15	15	
C	26 3/4	26 3/4	26 3/4	
D	0 to 5	0 to 5	0 to 5	

Universal Offset/ Wall Support

This part is designed to support the chimney above the offset on a vertical wall. The triangular plates allow a 2- to 4-inch lateral adjustment of the support to the vertical surface. This support can also be used as a wall support. When used as a wall support, it lends itself to the addition of an insulated tee cap. (Refer to the chart for loadbearing capacity.)

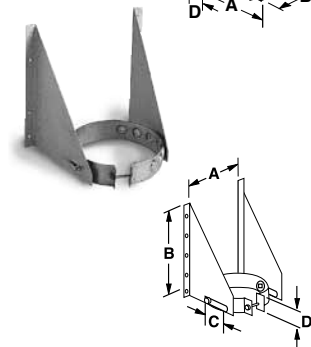

Ref. PSO					
Fits 5, 6, 7 and 8" HT6103+					
Ø int.	5	6	7	8	
A	8 1/2	9 1/2	10 1/2	11 1/2	
B	12	12	12	12	
C	2 3/4	2 3/4	2 3/4	2 3/4	
D	2	2	2	2	

Ref. PXSO				
Fits 6, 7 and 8" HT6000+ and 10" HT6103+				
Ø int.	6	7	8	10
A	11 1/2	12 1/2	13 1/2	13 1/2
B	12	12	12	12
C	2 3/4	2 3/4	2 3/4	2 3/4
D	2	2	2	2

Finishing Support with Coupler

This part supports the chimney from a ceiling. Designed to connect the black stovepipe, it is enhanced by a decorative black matte finish. It must be attached to a frame built from the joists. (Refer to the chart for loadbearing capacity.)



Round Cathedral Support with Coupler

This part supports the chimney from a cathedral ceiling. Designed to connect the black stovepipe, it comes in a decorative black matte finish and must be attached to a frame built from the joists. (Refer to the chart for loadbearing capacity.)

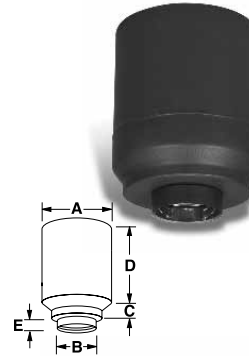

Square Cathedral Support with Coupler

This part supports the chimney from a cathedral ceiling. Designed to connect the black stovepipe, it comes in a decorative black matte finish and must be attached to a frame built from the joists. (Refer to the chart for loadbearing capacity.)

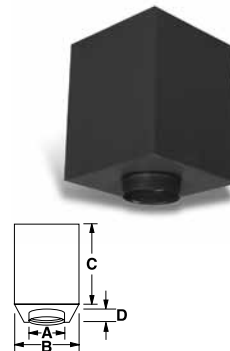

Square Support Extension

This part is designed to extend the finish of the cathedral support when the pitch of the roof is quite steep. It must be attached to the square cathedral support. It fits all diameters of the square cathedral support. Also available for 6-inch installations.

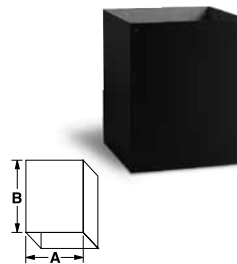

Projet Nova Temp™ HT6103+

Ref. 61--FCSC			
Ø int.	6	7	8
A	12	14 3/8	14 3/8
B	6 15/64	7 1/4	8 1/4
C	17	20	20
D	5 1/2	5 1/2	5 1/2
E	3	3	3
F	2	2	2

Projet Nova Temp™ HT6000+

Ref. 60--FCSC			
Ø int.	6	7	8
A	14 3/8	14 3/8	14 3/8
B	6 15/64	7 1/4	8 1/4
C	20	20	20
D	5 1/2	5 1/2	5 1/2
E	3	3	3
F	2	2	2

Ref. 61--CSC			
Ø int.	6	7	8
A	12	14 3/8	14 3/8
B	6 15/64	7 1/4	8 1/4
C	3	3	3
D	13	13	13
E	2	2	2

Ref. 60--CSC			
Ø int.	6	7	8
A	14 3/8	14 3/8	14 3/8
B	6 15/64	7 1/4	8 1/4
C	3	3	3
D	13	13	13
E	2	2	2

Ref. 61--CSBC			
Ø int.	6	7	8
A	6 15/64	7 1/4	8 1/4
B	12	14 3/8	14 3/8
C	17	17	17
D	2	2	2

Ref. 60--CSBC			
Ø int.	6	7	8
A	6 15/64	7 1/4	8 1/4
B	14 3/8	14 3/8	14 3/8
C	17	17	17
D	2	2	2

Ref. PPS (for 7" & 8" only)	
A	14 3/8
B	17

Ref. 6PPS (6" only)	
A	12
B	17

HT6103+ HT6000+

Premium Shield Accessories (For enclosed installation on wood stoves only)

Swivel Adaptor

Designed for use as an option to ease the connection in tight spaces between the flexible shield and the radiation shield connector (SRS).

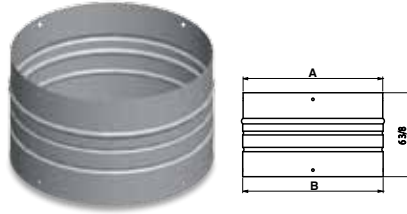

Ref. ASP

Ø int.	6	7	8
A ext.	10-19/32	11-19/32	12-19/32
B ext.	10-11/16	11-11/16	12-11/16

Telescopic Rigid Shield

Used as a casing shield around the chimney only where it is enclosed inside a building (for example, between floors or in a chase). It attaches with screws to a radiation shield connector at each floor/ceiling.

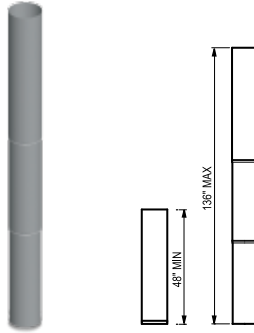

Ref. TRS

Ø int.	6	7	8
--------	---	---	---

Flexible Shield

Designed for use in the same applications as a rigid shield where an offset is required.

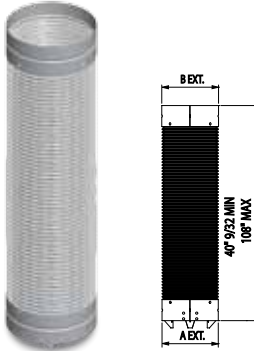

Ref. FLS

Ø int.	6	7	8
A ext.	10-19/32	11-19/32	12-19/32
B ext.	10-11/16	11-11/16	12-11/16

Radiation Shield Connector (Insulated)

Used in conjunction with a radiation shield connector support (RSSR) or firestop (RCSP) where the enclosed chimney passes through a ceiling/floor. It attaches to the chimney using 4 screws through brackets. A storm collar must be used at the top in an attic installation.

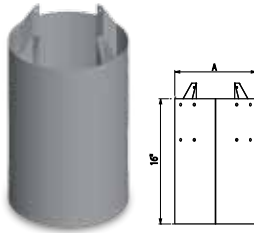

Ref. SRS

Ø int.	6	7	8
A ext.	10-13/32	11-13/32	12-13/32

Insulation pad included.

Radiation Shield Connector Firestop

Designed for use in conjunction with a radiation shield connector (SRS) on floors where the chimney runs through.

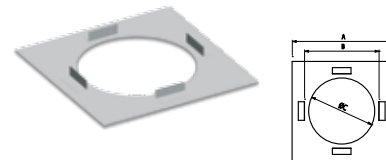

Ref. RCSP

Ø int.	6	7	8
A	16	16	16
B	12	13	14
C	10-21/32	11-21/32	12-21/32

Radiation Shield Connector Support

Used in conjunction with a radiation shield connector (SRS) on floors where the chimney needs to be supported (for example, after an offset).



Ref. RSSR

Ø int.	6	7	8
A ext.	10-17/32	11-17/32	12-17/32
B ext.	15	16	17

Projet Nova Temp™ HT6103+

Ref. 61--AP

Ø int.	5	6	7	8	10
A	5	6	7	8	10
B	12	12	12	12	14
C	2	2	2	2	2
D	3	3	3	3	3

Projet Nova Temp™ HT6000+

Ref. 60--AP

Ø int.	6	7	8
A	6	7	8
B	14	14	14
C	2	2	2
D	3	3	3

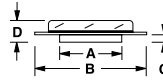

Ref. PUP

Ø int.	5	6	7	8	10
A	3	3	3	3	3
B	5	6	7	8	10

Ref. PUP

Ø int.	5	6	7	8	10
A	3	3	3	3	3
B	5	6	7	8	10

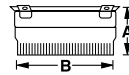

Ref. 61--CFRS

Ø int.	5	6	7	8	10
A	16	16	16	16	18
B	10	11	12	13	15
C	10	10	10	10	10

Ref. 60--CFRS

Ø int.	6	7	8
A	16	18	18
B	13	14	15
C	10	10	10

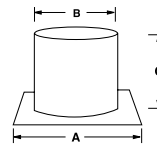

Ref. 61--IWRS

Ø int.		7	8	10
A		16	16	18
B		3	3	3
C		13	13	15

Ref. 60--IWRS

Ø int.		7	8
A		18	18
B		3	3
C		14	14

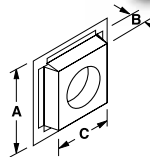
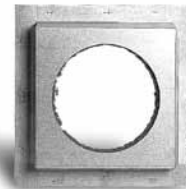

Ref. 61--WRS

Ø int.	5	6	7	8	10
A	17	17	20	20	
B	7 1/4	8 1/4	9 1/4	10 1/4	
C	← 7 to 12 1/2 →				
D	14	16	16	16	18
E	11	12	13	14	

Ref. 60--WRS

Ø int.	6	7	8
A	20	20	20
B	10 3/8	11 3/8	12 3/8
C	← 7 to 12 1/2 →		
D	16	16	18
E	14	15	16

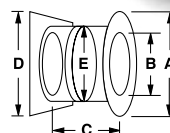

Anchor Plate

This part is attached to a masonry (HT6000+) or metal-casing fireplace to provide a proper connection to the chimney. It can also serve to connect a furnace.

Flue Extension

Fitted to the base of the first chimney length, this component makes it possible to extend the inner casing, thereby facilitating the attachment of a connector or base tee, or when connecting directly to the appliance outlet, and for the **Projet Nova Temp™ HT6000+**, of a single or double-wall stove pipe. The crimped end of this component is slightly tapered for easier assembly.

Radiation Shield

Protects combustible materials when the chimney passes through a floor or an intermediate ceiling. It ensures a 2-inch safety clearance between the chimney's outer casing and surrounding combustibles.

When passing through a ceiling, it must be installed from the underside of the ceiling. (Required in some jurisdictions.)

Insulated Radiation Shield

Designed for use with wood-burning fireplaces, such as the line of Security Fireplaces and other units certified for use with the **Projet Nova Temp™ HT6103+** and **HT6000+** chimneys, it should be used where the chimney passes through a ceiling or exterior opening where insulation is required. It must be used in combination with an attic radiation shield when passing through an attic. Recommended for use in cold regions.

Insulated Wall Radiation Shield

Designed to protect surrounding combustible materials when a chimney crosses through a wall horizontally, this shield can be adjusted from 7 to 12-1/2 inches to adapt to the thickness of the wall opening. A decorative plate painted in matte black provides an interior finish.

PROJET Nova Temp™ PRODUCT SPECIFICATIONS

HT6103+ HT6000+

Firestop

For use when the chimney passes through combustible materials.

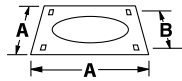

Projet Nova Temp™ HT6103+

Ref. 61--FS					
Ø int.	5	6	7	8	10
A	16	16	16	16	18
B	11	12	13	14	16

Projet Nova Temp™ HT6000+

Ref. 60--FS			
Ø int.	6	7	8
A	16	18	18
B	14	15	16

Two-Piece Insulated Attic Radiation Shield

It protects combustible materials when a chimney passes through an attic. It is imperative that it be installed overside from the attic. Its cone shape keeps insulation from seeping between the outer casing and the firestop. It also maintains a 2-inch clearance from combustible materials.

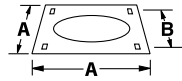

Ref. 61--AFRS2					
Ø int.	5	6	7	8	10
A	11	12	13	14	16
B	11	12	13	14	16
C	12	12	12	12	12
D	16	16	16	16	18

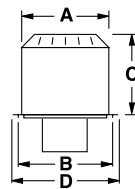

Ref. 60--AFRS2			
Ø int.	6	7	8
A	14	15	16
B	14	15	16
C	12	12	12
D	16	18	18

Adjustable Insulated Attic Radiation Shield

This has the same features as the two-piece insulated attic radiation shield but its height is adjustable from 12 to 22 inches.

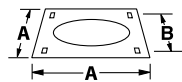

Ref. 61--AAFRS					
Ø int.	5	6	7	8	10
A	11	12	13	14	16
B	11	12	13	14	16
C	16	16	16	16	18

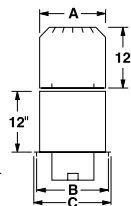

Ref. 60--AAFRS			
Ø int.	6	7	8
A	14	15	16
B	14	15	16
C	16	18	18

Insulated Wall Radiation Shield 30° and 45°

These parts are to be used only with wood-burning fireplaces in the Security Fireplace line, and others that have been certified for use with the chimney. It has been designed for use when the chimney passes through a wall at a 30° or 45° angle.

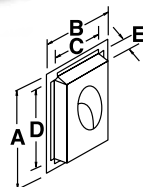

Ref. 61--IWR530				
Ø int.	6	7	8	10
A	34 3/4	37 1/4	39 1/4	42 13/16
B	15 1/8	16 1/8	17 1/8	18 1/8
C	17 1/8	18 1/8	19 1/8	20 1/8
D	36 3/4	39 1/4	41 1/4	44 13/16
E	3	3	3	3

Ref. 60--IWR530			
Ø int.	6	7	8
A	38 3/4	40 3/4	42 13/16
B	16 7/8	17 7/8	18 7/8
C	18 7/8	19 7/8	20 7/8
D	40 11/16	42 3/4	44 13/16
E	3	3	3

Ref. 61--IWR545				
Ø int.	6	7	8	10
A	24 3/8	26 1/8	27 1/2	30
B	15 1/8	16 1/8	17 1/8	18 1/8
C	17 1/8	18 1/8	19 1/8	20 7/8
D	26 11/32	18 1/8	19 1/2	32
E	3	3	3	3

Ref. 60--IWR545			
Ø int.	6	7	8
A	27 1/2	28 5/8	30
B	17 1/8	17 7/8	18 7/8
C	19 1/8	19 7/8	20 7/8
D	29 1/2	30 3/8	32
E	3	3	3

Ref. PBM

Fits 5, 6, 7 and 8" HT6103+

Ø int.	5	6	7	8
A	7	8	9	10
B	19	21	23	25
C	2	2	2	2

Ref. PXBM

Fits 6, 7 and 8" HT6000+ and 10" HT6103+

Ø int.	6	7	8	10
A	10	11	12	12
B	25	27	29	29
C	2	2	2	2

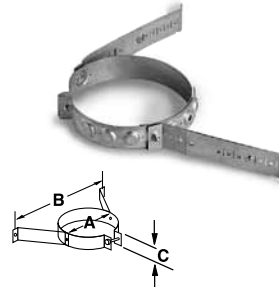

Universal Wall Band

Designed for use on an interior or exterior wall, it serves to stabilize the chimney while providing the required clearance from the combustible surface. The use of wall bands at maximum intervals of 8 feet is recommended.

Ref. PBS2

Fits 5, 6, 7 and 8" HT6103+

Ø int.	5	6	7	8
A	7	8	9	10
B	← 60 to 115 →			

Ref. PXBS2

Fits 6, 7 et 8" HT6000+ and 10" HT6103+

Ø int.	6	7	8	10
A	10	11	12	12
B	← 60 to 115 →			

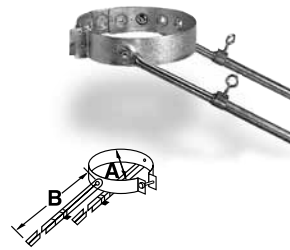

Universal Roof Brace

Designed to stabilize a chimney extending from 60 to 115 inches beyond the roof, or when a chimney is exposed to high winds, this part is supplied with tightening collar and adjustable legs.

Ref. 61--GWB

Ø int.	6	7	8	10
A	2	2	2	2



Guy Wire Band

Attached to the outer casing of the chimney (secured by bolts), it is designed to hold 3 guy wires. It is recommended for chimneys exceeding the roof by 5 to 13 feet maximum. Wire not included.

HT6103+ HT6000+

Flat Roof Flashing

This component seals a chimney length protruding from a flat roof and comes complete with a storm collar.

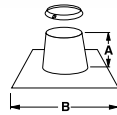

Projet Nova Temp™ HT6103+

Ref. 61--RFO					
Ø int.	5	6	7	8	10
A	7 1/2	7 1/2	7 1/2	7 1/2	7 1/2
B	20	24	24	24	24

Projet Nova Temp™ HT6000+

Ref. 60--RFO			
Ø int.	6	7	8
A	7 1/2	7 1/2	7 1/2
B	24	24	24

Peak Roof Flashing

This component is required for chimney installations passing through the roof peak.

It is available in two models:

- Peak roof: 1/12 to 7/12
61--RFP17/60--RFP17
- Peak roof: 8/12 to 12/12
61--RFP812/60--RFP812

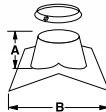

Ref. 61--RFP17/61--RFP812					
Ø int.	6	7	8	10	
Ref. 61--RFP17					
A	3 5/8	3 5/8	3 5/8	3 5/8	
B	12	13	13 1/2	15	
Ref. 61--RFP812					
A	5	4	3 1/4	1 1/2	
B	14	14	14	14	

Ref. 60--RFP17/60--RFP812			
Ø int.	6	7	8
Ref. 60--RFP17			
A	3 5/8	3 5/8	3 5/8
B	13 1/2	14	15
Ref. 60--RFP812			
A	3 1/2	3 1/2	3 1/2
B	14	14	14

Adjustable Roof Flashing

Projet Nova Temp™ HT6103+

This part is required to accommodate sloped roof installations.

Available in five versions to adapt to the needs of the following roof slopes:

- 1/12 to 7/12 pitch: 61--RF17
- 8/12 to 12/12 pitch: 61--RF812
- 12/12 to 21/12 pitch: 61--RF1221

Also available in aluminum malleable base plate in 6, 7 and 8 inches. I.D.
(Ref: 61--RFA17, 61--RFA812)
(Projet Nova Temp™ HT6103+ only)

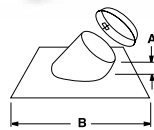

Ref. 61--RF17/RF812/RF1221					
Ø int.	5	6	7	8	10
Ref. 61--RF17					
A	6	6	6	6	6
B	24	24	24	24	28
Ref. 61--RF812					
A	6	6	6 3/8	6 7/8	6 7/8
B	24	24	24	30	
Ref. 61--RF1221					
A	6 1/4	6 1/4	6 1/4	6 1/4	
B	36	36	36	42	
Ref. 61--RFA17					
A	6	6	6		
B	36	36	36		
Ref. 61--RFA812					
A	6	6 3/8	6 7/8		
B	36	36	36		

Ref. 60--RF17/RF812/RF1221			
Ø int.	6	7	8
Ref. 60--RF17			
A	6	6	6
B	24	24	28
Ref. 60--RF812			
A	3 7/8	3 7/8	4 1/2
B	24	24	30
Ref. 60--RF1221			
A	6 1/4	6 1/4	6 1/4
B	36	40	42

Projet Nova Temp™ HT6000+

This part is required to accommodate sloped roof installations. It comes with a storm collar.

Three models are available to adapt to the needs of the following roof slopes:

- 1/12 to 7/12 pitch: 60--RF17
- 8/12 to 12/12 pitch: 60--RF812
- 12/12 to 21/12 pitch: 60--RF1221

Storm Collar

Designed to fit over flashings, it provides a watertight seal. It is automatically supplied with roof flashings.

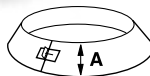

Ref. 61--SC					
Ø int.	5	6	7	8	10
A	5	5	5	5	5

Ref. 60--SC			
Ø int.	6	7	8
A	5	5	5

Projet Nova Temp™ HT6103+

Ref. 61--RCD

Ø int.	5	6	7	8	10
A	4¾	4¾	4¾	4¾	4¾
B	15	15	15	15	15

Projet Nova Temp™ HT6000+

Ref. 61--RCD

Ø int.	5	6	7	8
A	4¾	4¾	4¾	4¾
B	15	15	15	15

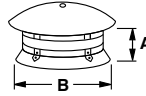

Rain Cap

Attached to the top of the chimney, it effectively prevents rain, snow or leaves from entering the opening. Universal to **Projet Nova Temp™** HT6103+ and HT6000+.

Ref. PPE

Universal to **Projet Nova Temp™** HT6103+ and HT6000+ termination cap, fits all diameters

Ref. PPE

Universal to **Projet Nova Temp™** HT6103+ and HT6000+ termination cap, fits all diameters

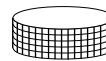
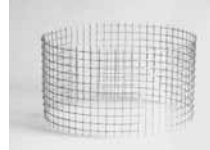

Spark Arrester Band

This spark arrester band is wrapped around the rain cap, preventing sparks from falling on the roof. Universal to **Projet Nova Temp™** HT6103+ and HT6000+.

Ref. 61--TRC

Ø int.	6	7	8
A	17	20	20
B	10	11	12

Ref. 60--TRC

Ø int.	6	7	8
A	20	20	20
B	10	11	12

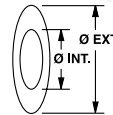

Trim Collar

The use of this trim collar provides a flawless finish when a chimney must pass through a ceiling or non-combustible wall.

Ref. 61--PB

Ø int.	6	7	8
A	10	11	12
B	6	7	8
C	1	1	1

Ref. 60--PB

Ø int.	6	7	8
A	10	11	12
B	6	7	8
C	1	1	1

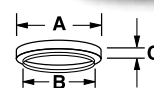

Decorative Collar

This component provides a finish between the **Projet Nova Temp™** HT6000+ chimney's female coupler and the appliance connector.

Ref. PPA

Ø int.	6	7	8
A	12	12	12

Ref. PXPA

Ø int.	6	7	8
A	12	12	12



Black Pipe Adaptor

This component is recommended for connecting a standard black pipe to the **Projet Nova Temp™** HT6000+ chimney when a longer extension length is required. A finishing collar is supplied.

Ref. PPD

Ø int.	6	7	8
A	12	14¾	14¾
B	6¼	7¼	8¼
C	5½	5½	5½

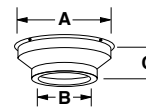

Finishing Cone

When the chimney passes through an exterior wall, a finishing cone may be necessary. It is designed to conceal the -protrusion of the insulated length (5 inches) inside, and makes it possible to respect the 6-inch clearance permitted by Oliver MacLead's double-wall black pipe. A flue extension must be used to ensure a perfect connection between the chimney and the stove connector.

PROJET Nova Temp™

HT6103+ HT6000+

Over the past 50 years, Oliver MacLeod's dedication to engineering excellence has led to the development of a wide range of quality venting products as well as wood-burning fireplaces.

The line of products manufactured and marketed by Security Chimneys International includes:

TUBINOX (STAINLESS STEEL LINER)

- To reline an existing masonry chimney, or to substitute the clay liner in a new masonry chimney.
- Certified to ULC-S635M, UL-1777 and ULC-S640M standards.
- Available in diameters of 5 and 8 inches.

SPX VENT FOR PELLETIZED-FUEL APPLIANCES

- Aluminum-zinc coated steel outer casing for better corrosion resistance.
- Attractive black-painted outer casing also available.
- Durable stainless steel flue.
- New and improved twist-lock connecting system.
- Leakproof tested.
- Extra-durable 304 stainless steel flue.

PROJET DW (DOUBLE-WALLED BLACK STOVEPIPE)

- Double-wall black stove connector for use with wood-burning stove.
- Available in diameters of 6, 7 and 8 inches.

Specifications are subject to change without prior notice.

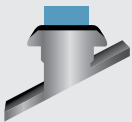

**SECURITY CHIMNEYS
INTERNATIONAL™**

Security Chimneys International Ltd.
2125 Monterey
Laval, Quebec
Canada H7L 3T6
Tel.: (450) 973-9999
Fax.: (450) 973-2222



Printed in Canada
AC6103/6000-2
REV: 8 1-2012

©Lennox Industries Inc. 2012

Distributed by:

Visit us at: www.SecurityChimneys.com