



Secure Black[®]

Single and Double Wall Stove Pipe



www.securitychimneys.com
800-361-4909 (US) 800-667-3387 (Canada)

Secure Black® Double Wall

The Secure Black Double Wall (DL) stove pipe from Security Chimneys is tested to 2100°F and listed as 6" clearance from combustible materials for all types of wood-burning stoves. The double wall black stove connector features a series of openings, allowing for maximum recovery of heat from flue gases.

A TRADITION OF EXCELLENCE

For over 50 years, Security Chimneys has been an innovator in the venting field and a market leader in North America. Instrumental in the company's growth has been an ongoing focus on product improvement and the introduction of new, innovative products. The proven Secure Black Double Wall pipe is just one example of this commitment to engineering solutions that outperform.

SAFE, DURABLE, AND EFFICIENT

With the Secure Black® Double Wall (DL) pipe, Security Chimneys has designed a product that has been successfully tested to 2100°F at a 6-inch clearance from combustible materials. This level of safety delivers the peace of mind your customers demand. Temperature rating of 1000°F Max continuous; 1400°F brief forced fired; and 2100°F 30 minutes tested.

The inner liner is made of corrosion-resistant stainless steel, helping to deliver better protection of the exterior finish. The outer wall features a series of openings that allow for maximum recovery of heat from the flue gases. In fact, it is almost as efficient as a single wall black pipe.

DESIGNED FOR INSTALLATION EASE

The Security Double Wall black stove pipe can be safely installed as close as 6 inches to combustible materials, providing greater installation flexibility. Furthermore, it may be used with all types of stoves and is available in diameters of 6, 7 and 8 inches.

To simplify installation, Security Chimneys has designed a telescopic double wall black pipe, which extends from 3-1/2 feet to 5-1/2 feet. There is no need to determine the number of lengths required and no need for cutting—it will adjust to your application.

LONG-LASTING ASSURANCE

Security Chimneys Ltd. warrants a limited lifetime warranty for its double wall black stove pipe.



SECURITY CHIMNEYS SECURE BLACK DOUBLE WALL STOVE PIPE



Features	Benefits
Exclusive twist-lock assembly	<ul style="list-style-type: none"> • No screws or other attachments required • Fast and easy installation with 1/8-inch turn
Stainless steel inner lining	<ul style="list-style-type: none"> • Low reaction to heat • Thin inner lining for immediate heating • Provides smoother surface • Little restriction of flue gases even with a 45° elbow • Resists outstanding corrosion
Outer wall with series of openings	<ul style="list-style-type: none"> • Allows for maximum recovery of heat from the flue gases • Supports the structural load • Provides low surface temperature
Telescopic design extends from 3-1/2 feet to 5-1/2 feet	<ul style="list-style-type: none"> • Adjusts to the application • No need to predetermine lengths • No need for cutting • Saves time and material costs
Limited lifetime warranty	<ul style="list-style-type: none"> • Assures product confidence and peace of mind

INSTALLATION KEY

- 1 Insulated Chimney
- 2 Finishing Support
- 3 Telescopic Length
- 4 Appliance
- 5 Storm Collar
- 6 Roof Flashing
- 7 Cathedral Support
- 8 Double Wall Lengths
- 9 Wall Thimble
- 10 Decorative Collar
- 11 Elbow
- 12 Wall Support
- 13 Insulated Tee
- 14 Insulated Chimney Flue Extension

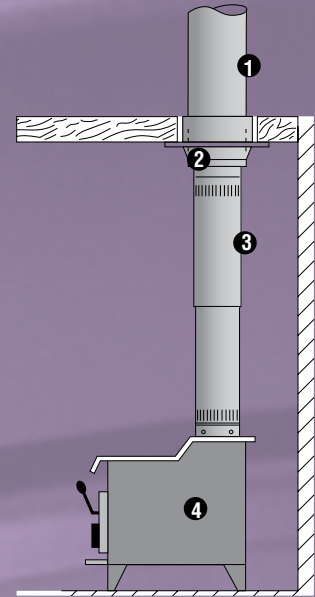

Straight installation

This double wall stove pipe is used to connect a solid, liquid or gas fired appliance to a factory built or masonry chimney.

The clearance between the stove pipe and combustible material must not be less than 6 inches.

Do not enclose this stove pipe.

This stove pipe must not pass through attics, closets, walls, or ceilings.

Never overfire your stove. If any part of the stove or pipe is glowing red, then you are overfiring. Immediately close the stove's dampers until the system cools. The high temperature caused by overfiring can permanently damage the stove and may overheat nearby combustible walls and furniture.

Install the stove and stove pipe as described in the installation instructions accompanying the stove. Be certain to maintain the required clearances to combustible construction.

Do not burn sea driftwood or treated wood. Salt and chemical components are highly corrosive to all types of stainless steel.

ELBOW OFFSET & RISE CHART

Diameter		Length between elbows				
		None	6"	12"	24"	36"
6	Offset	2-1/4"	5-1/4"	9-1/2"	18"	26-1/2"
	Rise	11-3/4"	14-1/4"	18-1/2"	27"	35-1/2"
7	Offset	3"	6"	10-1/4"	18-3/4"	27-1/4"
	Rise	12"	15"	19-1/4"	27-3/4"	36-1/4"
8	Offset	3-1/4"	6-1/4"	10-1/2"	19"	27-1/2"
	Rise	13-1/2"	16-1/2"	20-3/4"	29-1/4"	37-3/4"

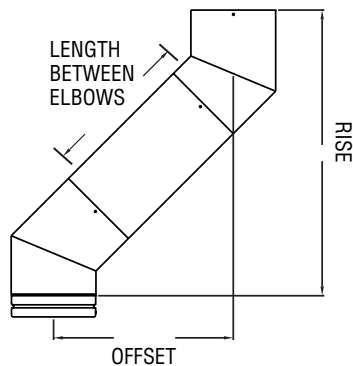

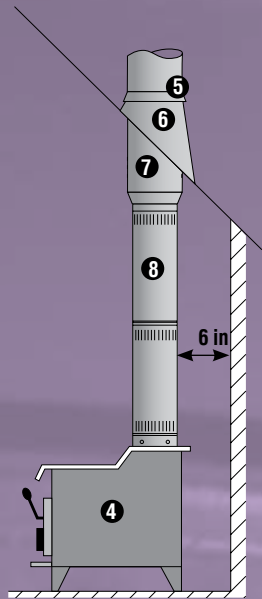

Cathedral ceiling installation

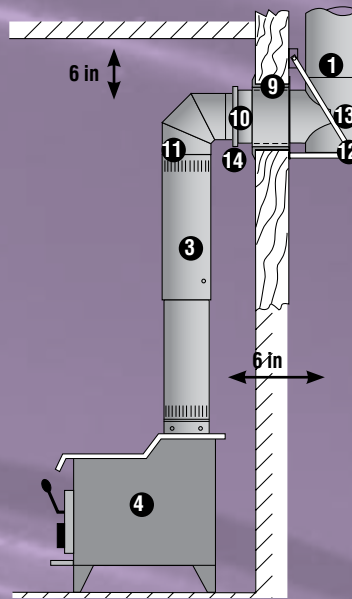

Through-the-wall installation

Installation

Masonry Chimney

Have your chimney inspected by a qualified chimney sweep or Fire Department Inspector before using it. Masonry chimneys should only be used if they are in good condition and have been built to the National Building Code.

There should be a horizontal opening into the chimney through a non-combustible wall. Fit the Masonry Adaptor (DMA) into this hole. Attach the adaptor collar to the masonry wall using screws and masonry anchors. Seal the joint between the collar and the masonry with a high temperature silicone caulking.

Install the chimney and stove in accordance with their Installation Instructions.

The clearance between the stove connector and any combustible material must not be less than 6 in.

For most straight installations, only a telescopic length and trim collar will be required. The telescopic length adjusts from 3'6" to 5'6".

For installations that require more than one length, we recommend that the maximum vertical length of double wall black connector that can be installed should be 20'.

Creosote

Smoke from a wood fire always contains some unburned gases and a fog of unburned tarlike liquids. When these materials condense they form a dark brown or black deposit called creosote. Creosote formation in a chimney cannot be eliminated, but it can be minimized by:

1. Keeping the temperature of the gases in the chimney above 300°F.
2. Making small hot fires rather than slow burning, smoldering fires.

Coal

Some coals contain large quantities of Sulphur (up to 7%). When coal is burned, Sulphur and coal ashes are deposited in the chimney flue. This deposit combines with moisture to form a highly corrosive acid (Sulphuric Acid). In order to protect your chimney connector, we recommend that you:

1. Burn only low Sulphur coals (less than 1% Sulphur).
2. Have your chimney cleaned within 48 hours of shutting down your stove at the end of the heating season. Be certain that all the soot is removed. Wipe the chimney flue using a strong solution of baking soda and water. This can be done by wrapping a rag around a chimney cleaning brush, dipping it in the baking soda-water solution, then passing it through the chimney three or four times.

DL Lengths

Double Wall Lengths

Designed for installation with minimum clearance of 6" to combustible material. Available in 6", 7", and 8" diameters.

A	B*	Product Code
6"	4-1/8"	6DL6
6"	10-1/8"	6DL12
6"	22-1/8"	6DL24
6"	34-1/8"	6DL36
7"	4-1/8"	7DL6
7"	10-1/8"	7DL12
7"	22-1/8"	7DL24
7"	34-1/8"	7DL36
8"	4-1/8"	8DL6
8"	10-1/8"	8DL12
8"	22-1/8"	8DL24
8"	34-1/8"	8DL36

*Effective length

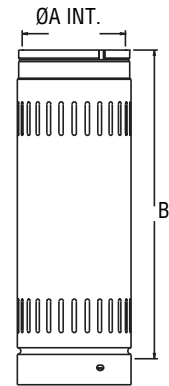

Double Wall Telescopic Lengths

Use for a two-piece installation from stove to ceiling support box or finishing collar. No cutting required.

A	B*	Product Code
6"	42 @ 66"	6DL42A
7"	42 @ 66"	7DL42A
8"	42 @ 66"	8DL42A

*Effective length

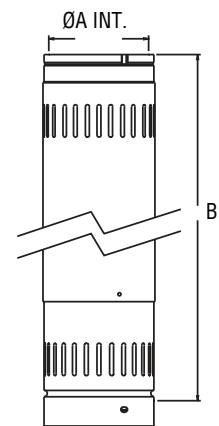

Double Wall Adjustable Lengths

Slide over a regular length.

A	B	C*	Product Code
6"	12"	3 @ 9"	6DL3A
6"	36"	3 @ 34"	6DL36A
7"	12"	3 @ 9"	7DL3A
7"	36"	3 @ 34"	7DL36A
8"	12"	3 @ 9"	8DL3A
8"	36"	3 @ 34"	8DL36A

*Adjustment range

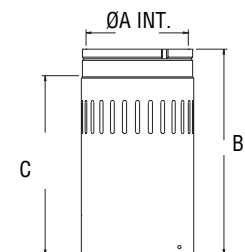

DL Lengths

Double Wall Increaser

Use to increase from a smaller appliance flue outlet to larger diameter chimney or stovepipe.

A	B	Product Code
7"	6"	6DLW7
8"	7"	7DLW8
8"	6"	6DLW8

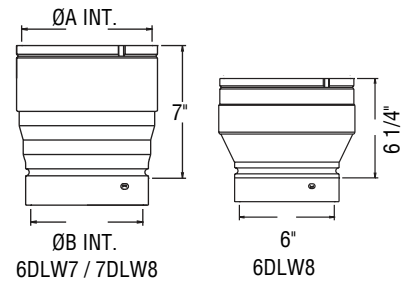

Double Wall Reducer

Use to decrease the appliance outlet only when approved by the appliance manufacturer or authority having jurisdiction.

A	B	Product Code
6"	7"	7DLR6
7"	8"	8DLR7
6"	8"	8DLR6

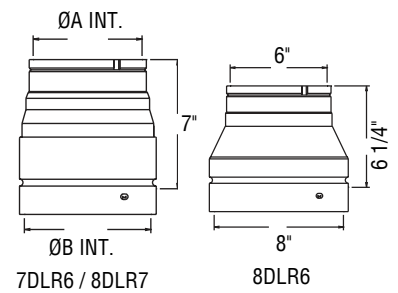

Double Wall Stove Adaptor

Can be required to connect to a stove.

A	B	Product Code
6"	—	6DAB
7"	—	7DAB
8"	—	8DAB

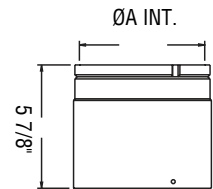

DL Elbows

Double Wall 45-Degree Elbows

Offsets obstructions as needed.

A	B	C	Product Code
6"	5-1/4"	2-7/16"	6DE45
7"	5-1/2"	2-5/8"	7DE45
8"	6-1/4"	2-3/4"	8DE45

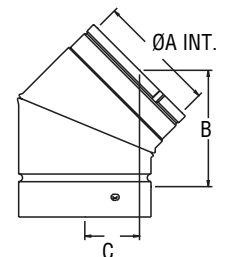

DL Elbows

Double Wall 90-Degree Elbows

Offsets obstructions as needed.

A	B	C	Product Code
6"	5-5/32"	5-23/32"	6DE90
7"	5-3/4"	6-5/8"	7DE90
8"	7-11/16"	7-3/4"	8DE90

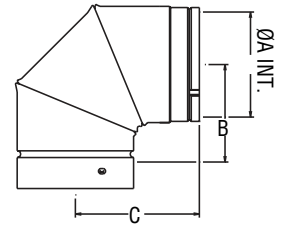

DL Tees

Double Wall Tees

Use with rear exit appliances and appliances that require a barometric damper.

A	B	C	D	Product Code
6"	10-1/4"	3"	6-1/16"	6DT
7"	12-1/4"	2-7/8"	7-1/16"	7DT
8"	14-1/4"	3"	8-1/16"	8DT

Tee cap included.

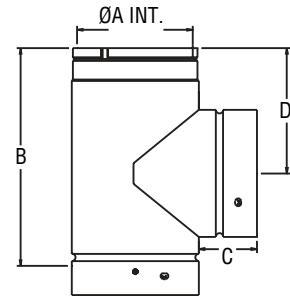

DL Accessories

Insulated Chimney Flue Extension

Can be required to connect to an insulated chimney.

A	B	Product Code
5-31/32"	6-1/16"	6UP
6-31/32"	7-1/16"	7UP
7-15/16"	8-1/16"	8UP

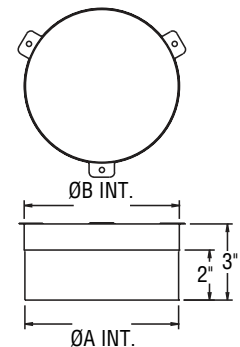

Double Wall Masonry Adaptor

Required to connect to a masonry chimney.

A	B	Product Code
6"	—	6DMA
7"	—	7DMA
8"	—	8DMA

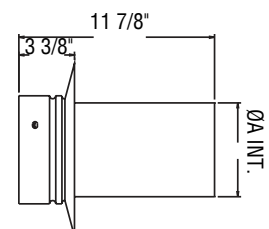

DL Accessories

Double Wall Decorative Collar

Conceals the joint between the double wall and the insulated chimney.
 *DQDH for ASHT chimney; DQDX for S2100 chimney (Canada only)

A	B	C	Product Code
8-1/8"	6-5/8"	1-3/8"	6DQDH
9-3/8"	7-5/8"	7/8"	7DQDH
10-3/8"	8-5/8"	7/8"	8DQDH
 			
10-1/8"	6-5/8"	7/8"	6DQDX
11-1/8"	7-5/8"	7/8"	7DQDX
12-1/8"	8-5/8"	7/8"	8DQDX

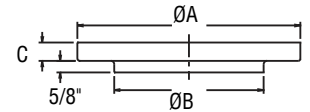

Double Wall Trim Collar

Can be used to cover the joint between the double wall and the insulated chimney.

A	B	Product Code
6-1/2"	—	6DQ
7-15/32"	—	7DQ
8-17/32"	—	8DQ

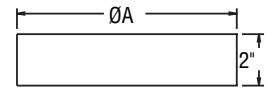

Double Wall Damper

Connects pipe to the appliance flue outlet. Use as a stove adapter.

A	B	Product Code
6"	—	6DLK
7"	—	7DLK
8"	—	8DLK

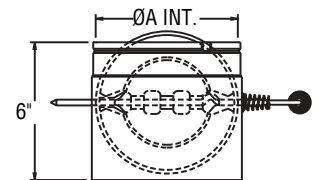

Required for chimney draft control.

Double Wall Oval-Round Adaptor

A	B	Product Code
6"	—	8DLORR6A
8"	—	8DLORA

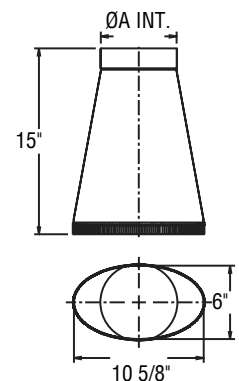

Secure Black® Single Wall

With the Single Wall (SW) offering in our Secure Black stove pipe line, Security Chimneys proudly delivers a full line of stove venting products. The SW provides the color match and installation ease that is ideal for your stove connection.

A COLOR THAT COMPLEMENTS

With the SW stove pipe, Security Chimneys is delivering a high-quality, competitive option with several distinct advantages. The matte black finish is one of them. By matching most black steel wood stoves on the market, this high-temperature stove paint provides a near-perfect, seamless transition from appliance to vent pipe. That means installations look significantly better and more aesthetically attractive than competitive offerings featuring a low-luster black. Customers will appreciate the difference!

INSTALLATION EASE AND QUALITY CONSTRUCTION

With Security Chimney's exclusive rib-reinforced die-formed male end fitting, installing a single wall pipe will be faster than ever before—helping reduce your valuable time on site and getting installers off to the next job. Simply slide the pipe over and screw in using self-tapping screws supplied to securely lock the SW into place.

With its 24-gauge construction, the SW is highly resilient and rivals any single wall offering available today. Security Chimneys also uses a seam weld to enhance the durability of the pipe. You and your customers can be assured that, even during the most demanding conditions, the SW will continue to perform to the highest standards.



SECURITY CHIMNEYS SECURE BLACK SINGLE WALL STOVE PIPE



Features	Benefits
Metallic black high-temperature stove paint - stove bright from forrest paint	<ul style="list-style-type: none">• Matches most stoves available on the market• Provides a seamless transition from stove to vent• Offers a better-looking, more attractive installation
24-gauge (0.024"), seam weld construction	<ul style="list-style-type: none">• Provides increased durability• Creates a rounder pipe for a better fit
Exclusive rib-reinforced male end fitting	<ul style="list-style-type: none">• Ensures a strong joint

INSTALLATION KEY

- 1 Insulated Chimney
- 2 Finishing Support
- 3 Telescopic Length
- 4 Appliance
- 5 Storm Collar
- 6 Roof Flashing
- 7 Cathedral Support
- 8 Single Wall lengths
- 9 Wall Thimble
- 10 Decorative Collar
- 11 Elbow
- 12 Wall Support
- 13 Insulated Tee

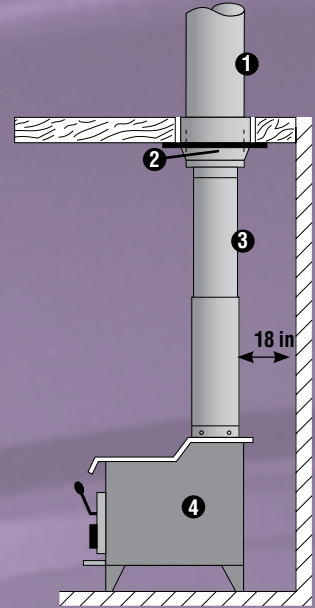

Straight installation

This single wall stove pipe is used to connect a solid, liquid or gas fired appliance to a factory built or masonry chimney.

Install the chimney and stove in accordance with their Installation Instructions.

The clearance between the stove pipe and combustible material must not be less than 18 inches.

Do not enclose this stove pipe.

This stove pipe must not pass through attics, closets, walls, or ceilings.

For most straight installations, only a telescopic length will be required. The telescopic length adjusts from 3'6" to 5'6".

Never use a single wall connector (stove pipe) in mobile home installations.

For installations that require more than one length, we recommend that the maximum vertical length of single wall black connector that can be installed should be 20'.

ELBOW OFFSET & RISE CHART

Diameter		Length between elbows				
		None	6"	12"	24"	36"
6	Offset	2-1/4"	5-1/4"	9-1/2"	18"	26-1/2"
	Rise	11-3/4"	14-1/4"	18-1/2"	27"	35-1/2"
7	Offset	3"	6"	10-1/4"	18-3/4"	27-1/4"
	Rise	12"	15"	19-1/4"	27-3/4"	36-1/4"
8	Offset	3-1/4"	6-1/4"	10-1/2"	19"	27-1/2"
	Rise	13-1/2"	16-1/2"	20-3/4"	29-1/4"	37-3/4"

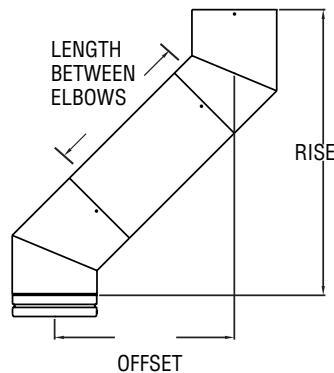

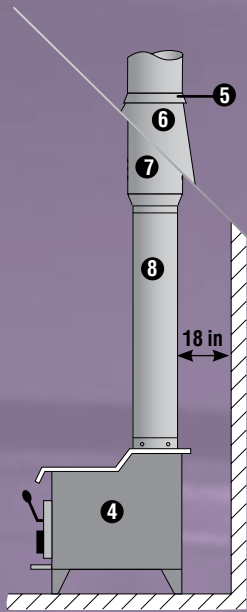

Cathedral ceiling installation

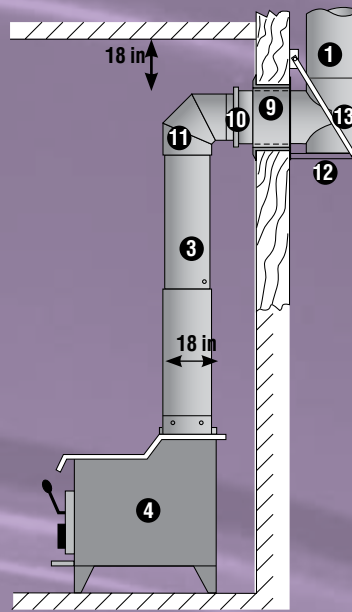

Through-the-wall installation

Installation

Masonry Chimney

Have your chimney inspected by a qualified chimney sweep or Fire Department Inspector before using it. Masonry chimneys should only be used if they are in good condition and have been built to the National Building Code.

There should be a horizontal opening into the chimney through a non-combustible wall. Fit the Masonry Adaptor (SWMA) into this hole. Attach the adaptor collar to the masonry wall using screws and masonry anchors. Seal the joint between the collar and the masonry with a high temperature silicone caulking.

Install the chimney and stove in accordance with their Installation Instructions.

The clearance between the stove connector and any combustible material must not be less than 18 in.

For most straight installations, only a telescopic length and trim collar will be required. The telescopic length adjusts from 3'6" to 5'6".

For installations that require more than one length, we recommend that the maximum vertical length of single wall black connector that can be installed should be 20'.

CREOSOTE

Smoke from a wood fire always contains some unburned gases and a fog of unburned tarlike liquids. When these materials condense they form a dark brown or black deposit called creosote. Creosote formation in a chimney cannot be eliminated, but it can be minimized by:

1. Keeping the temperature of the gases in the chimney above 300°F.
2. Making small hot fires rather than slow burning, smoldering fires.

COAL

Some coals contain large quantities of Sulphur (up to 7%). When coal is burned, Sulphur and coal ashes are deposited in the chimney flue. This deposit combines with moisture to form a highly corrosive acid (Sulphuric Acid). In order to protect your chimney connector, we recommend that you:

1. Burn only low Sulphur coals (less than 1% Sulphur).
2. Have your chimney cleaned within 48 hours of shutting down your stove at the end of the heating season. Be certain that all the soot is removed. Wipe the chimney flue using a strong solution of baking soda and water. This can be done by wrapping a rag around a chimney cleaning brush, dipping it in the baking soda-water solution, then passing it through the chimney three or four times.

SW Lengths

Single Wall Lengths

Use for a single-wall connector pipe.

A	B	C	Product Code
6"	6"	4-3/8"	6SWL6
6"	12"	10-3/8"	6SWL12
6"	24"	22-3/8"	6SWL24
6"	36"	34-3/8"	6SWL36
6"	48"	46-3/8"	6SWL48
7"	6"	4-3/8"	7SWL6
7"	12"	10-3/8"	7SWL12
7"	24"	22-3/8"	7SWL24
7"	36"	34-3/8"	7SWL36
7"	48"	46-3/8"	7SWL48
8"	6"	4-3/8"	8SWL6
8"	12"	10-3/8"	8SWL12
8"	24"	22-3/8"	8SWL24
8"	36"	34-3/8"	8SWL36
8"	48"	46-3/8"	8SWL48

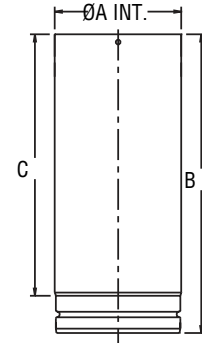

Single Wall Adjustable Lengths

Slide over a length.

A	B	C	Product Code
6"	12"	2 @ 8-1/2"	6SWLA
7"	12"	2 @ 8-1/2"	7SWLA
8"	12"	2 @ 8-1/2"	8SWLA

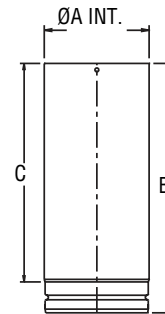

SW Lengths

Single Wall Telescopic Lengths

Use for a two-piece installation. Connects directly from stove to ceiling support box or finishing collar. No cutting required.

A	B	C	Product Code
6"	38 @ 69"	6SWLT	6SWLT
7"	38 @ 69"	7SWLT	7SWLT
8"	38 @ 69"	8SWLT	8SWLT

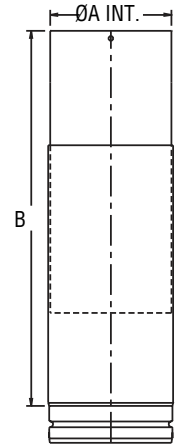

SW Elbows

Single Wall 45-Degree Elbows

Offsets obstructions as needed.

A	B	C	Product Code
6"	6-3/16"	3-3/16"	6SWE45
7"	6-3/16"	3-3/16"	7SWE45
8"	6-3/16"	3-3/16"	8SWE45

See Offset/Rise Chart on pg. 3 for deviation information.

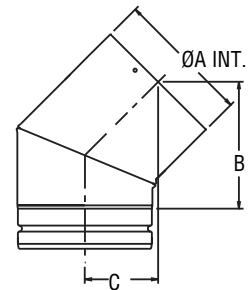

Single Wall 90-Degree Elbows

Offsets obstructions as needed.

A	B	C	Product Code
6"	6"	7-5/8"	6SWE90
7"	6"	7-5/8"	7SWE90
8"	6"	7-5/8"	8SWE90

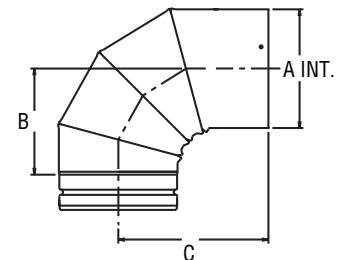

SW Tees

Single Wall Tees

Use with rear exit appliances and appliances that require a barometric damper.

A	B	C	D	Product Code
6"	12-1/4"	1-1/2"	6"	6SWT
7"	14-1/4"	1-1/2"	7"	7SWT
8"	16-1/4"	1-1/2"	8"	8SWT

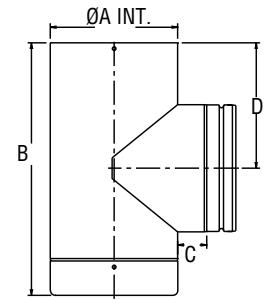

SW Accessories

Single Wall Increaser

Use to increase from a smaller appliance flue outlet to larger diameter chimney or stovepipe.

A	B	Product Code
7"	6"	6SWIN7
8"	7"	7SWIN8
8"	6"	6SWIN8

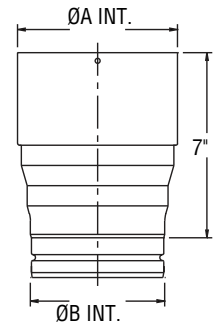

Single Wall Reducer

Use to decrease the appliance outlet only when approved by the appliance manufacturer or authority having jurisdiction.

A	B	Product Code
6"	7"	7SWR6
7"	8"	8SWR7
6"	8"	8SWR6

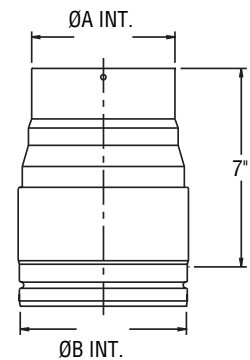

SW Accessories

Single Wall Decorative Collar

Conceals the joint between the single wall and the insulated chimney.
 *PB for ASHT chimney; XPB for S-2100 chimney (Canada only)

A	B	C	Product Code
6-1/8"	8-1/4"	7/8"	6PB
7-1/8"	9-1/4"	7/8"	7PB
8-1/8"	10-1/4"	7/8"	8PB
6-1/8"	10"	7/8"	6XPB
7-1/8"	11"	7/8"	7XPB
8-1/8"	12"	7/8"	8XPB

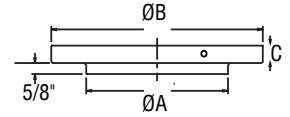

Single Wall Damper

Connects pipe to the appliance flue outlet. Use as a stove adaptor.

A	B	Product Code
6"	—	6SWLK
7"	—	7SWLK
8"	—	8SWLK

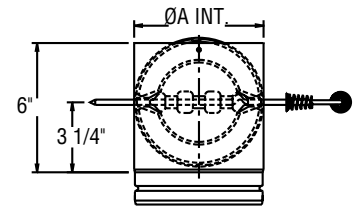

Single Wall Masonry Adaptor

A	B	Product Code
6"	—	6SWMA
7"	—	7SWMA
8"	—	8SWMA

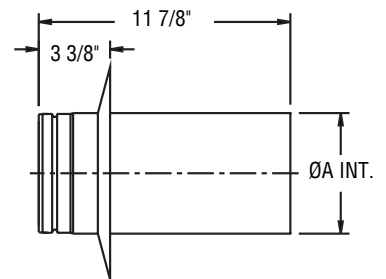

SW Accessories

Single Wall Oval-Round Adaptor

A	B	Product Code
6"	—	6SWOA
7"	—	7SWOA
8"	—	8SWOA

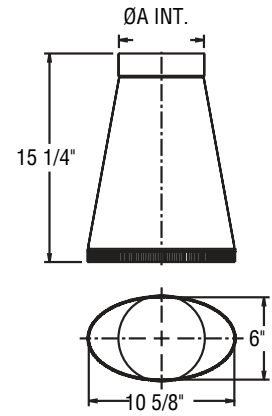

Single Wall Stove Adaptor

A	B	Product Code
6"	5-7/8"	6SWAB
7"	6-7/8"	7SWAB
8"	7-7/8"	8SWAB

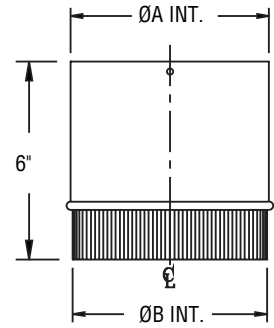

Limited Lifetime Warranty

This Security Chimneys International, Ltd. (SCIL) Limited Lifetime Warranty warrants your residential vent and/or chimney system to be free from defects in material and workmanship at the time of manufacture. This Limited Lifetime Warranty includes all components and fittings, except termination caps and Secure Black SW single wall black stove pipe. After installation, if covered components manufactured by SCIL are found to be defective in materials or workmanship during the Limited Lifetime Warranty period and while the Product remains at the site of the original installation, SCIL will, at its option, replace the covered components. SCIL reserves the right to replace covered components with an equivalent product and the replacement must be carried out in accordance with SCIL's recommendations. If replacement is not commercially practical, SCIL will, at its option, refund the purchase price or wholesale price of the SCIL product, whichever is applicable. THERE ARE EXCLUSIONS AND LIMITATIONS to this Limited Lifetime Warranty as described herein.

COVERAGE COMMENCEMENT DATE

Warranty coverage begins on the date of installation. In the case of new home construction, warranty coverage begins on the date of first occupancy of the dwelling or six months after the sale of the Product by an independent SCIL dealer/distributor, whichever occurs earlier. The warranty shall commence no later than 24 months following the date of product shipment from SCIL, regardless of the installation or occupancy date.

EXCLUSIONS AND LIMITATIONS

This Limited Lifetime Warranty applies only if the Product is installed in the United States or Canada and only if used for the application for which it was designed and intended. The Product must be maintained in accordance with the printed instructions accompanying the Product and in compliance with all applicable installation and building codes and good trade practices.

This warranty is transferable. The Product must be purchased through a listed supplier of SCIL and proof of purchase must be provided. SCIL will be responsible for the replacement of the residential vent and/or chimney system considered to be defective for the following periods:

Termination Caps & Secure Black SW Stove Pipe – Replacement at no charge for 5 years from the date of installation, excluding labor

Components and fittings (excludes termination caps and Secure Black SW) –

Year 1-15 – Replacement of all components and fittings (a labor allowance may apply to a maximum of 300 \$ * certain conditions apply).

Year 16 + – Replacement at 50% off of the prevailing list price in effect at the time of replacement (No labor allowance applies).

*Labor Allowance Conditions: Any Warranty replacement work must be performed by a Professional Installer.

SCIL will not be responsible for: (a) damages caused by normal wear and tear, corrosion from salt air, accident, riot, fire, flood or acts of God; (b) damages caused by abuse, negligence, misuse, or unauthorized alteration or repair of the Product affecting its stability or performance. (The Product must be subject to normal use with approved fuels listed in the Operation Manual provided with the product. Where applicable, fuel products with abnormal burning characteristics, including but not limited to fuel such as driftwood, plywood and wood products using a binder may burn at excessive temperatures and may cause damage to the Product or may cause it to function improperly; (c) damages caused by failing to provide proper maintenance and service in accordance with the instructions provided with the Product; (d) damages, repairs or inefficiency resulting from faulty installation or application of the Product.

This Limited Lifetime Warranty covers only parts as provided herein. SCIL's entire liability is limited to the purchase price of this product. In no case shall SCIL be responsible for materials, components or construction which are not manufactured or supplied by SCIL or for the labor necessary to install, repair or remove such materials, components or construction. Additional utility bills incurred due to any malfunction or defect in equipment are not covered by this Limited Lifetime Warranty. All replacement or repair components will be shipped F.O.B. from the nearest stocking SCIL factory.

LIMITATION ON LIABILITY

It is expressly agreed and understood that SCIL's sole obligation and the purchaser's exclusive remedy under this warranty, under any other warranty, expressed or implied, or in contract, tort or otherwise, shall be limited to replacement, repair, or refund, as specified herein.

In no event shall SCIL be liable for any incidental or consequential damages caused by defects in the Product, whether such damage occurs or is discovered before or after replacement or repair, and whether such damage is caused by SCIL's negligence. SCIL has not made and does not make any representation or warranty of fitness for a particular use or purpose, and there is no implied condition of fitness for a particular use or purpose. SCIL makes no expressed warranties except as stated in this Limited Lifetime Warranty. The duration of any implied warranty is limited to the duration of this expressed warranty.

No one is authorized to change this Limited Lifetime Warranty or to create for SCIL any other obligation or liability in connection with the Product. Some states and provinces do not allow the exclusion or limitation of incidental or consequential damages, so the above limitations or exclusions may not apply to you. The provisions of this Limited Lifetime Warranty are in addition to and not a modification of or subtraction from any statutory warranties and other rights and remedies provided by law.

INVESTIGATION OF CLAIMS AGAINST WARRANTY

SCIL reserves the right to investigate any and all claims against this Limited Lifetime Warranty and to decide, in its sole discretion, upon the method of settlement.

To receive the benefits and advantages described in this Limited Lifetime Warranty, the appliance must be installed and repaired by a licensed contractor approved by SCIL. Contact SCIL at the address provided herein to obtain a listing of approved dealers/distributors. SCIL shall in no event be responsible for any warranty work done by a contractor that is not approved without first obtaining SCIL's prior written consent.

HOW TO REGISTER A CLAIM AGAINST WARRANTY

In order for any claim under this warranty to be valid, you must contact the SCIL dealer/distributor from which you purchased the product. If you cannot locate the dealer/distributor, then you must notify SCIL in writing. SCIL must be notified of the claimed defect in writing within 90 days of the date of failure. Notices should be directed to the SCIL Warranty Department at 2125 Monterey Street, Laval, QC H7L 3T6.

www.securitychimneys.com

Security Chimneys

2125 Monterey, Laval, Quebec
Canada, H7L 3T6

450-973-9999

800-361-4909 (US)

800-667-3387 (Canada)

450-973-2222 (Fax)

Need product information or technical support? Our customer service specialists are ready to answer your questions:

800-667-3387 or contact
infoeng@securitychimneys.com



Information published in all Security Chimneys literature is current at time of publication and is subject to change without notice.

EDLSW

LS591_Catalog_Secure Black_05-10-17_V2

www.securitychimneys.com **800-361-4909 (US)** **800-667-3387 (Canada)**

Security Chimneys International © 2014 , 2017